

Catalogue

Manufacture and distribution
of components for transformers



→ AT THE HEART OF ENERGY

Since 1956

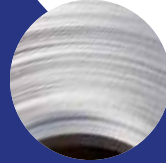

Isolectra Martin, leader in the manufacture and distribution of components for transformers.

Isolectra Martin manufactures magnetic cores (Silicon Steel C Cores, E Cores and Toroids) as well as winding bobbins and accessories for transformers.

The company relies on its network of European partners and on the experience gained since its creation in 1956 in order to bring you an extensive range of magnetic components and elements for transformers in the shortest possible time.

Standard dimensions or customised fabrications, Isolectra Martin adapts to meet your requirements.

The company also offers technical advice and services: epoxy coating, air gapping or bonding ferrite assemblies, cutting out insulation shapes, copper strips...

Isolectra Martin is keen to provide you with flexibility and satisfaction, offering you sustainable quality.

Our partners

Ferroxcube

Ferrites and mounting accessories...

www.ferroxcube.fr

Weisser

Bobbins, boxes, accessories for M, EI, UI, EE, ETD...

www.weisser.de

3M

Adhesive tapes for electrical insulation...

www.3M.com

Other products:

Transformer Laminations of standard E,U,I or customised laminations. Magnets, Iron Powder Toroids, Adhesives, Sales and Hire of Banding Pliers...

→ Summary

Isolectra partners	04
Product families - Types of assemblies	06
Product families - FA/SU/SM/SE type single-phase/three-phase rolled sheet metal-based assemblies	08
1 . Core-based assemblies	11
General information about single-phase cut cores	12
Calculation method for C core-based transformers	14
Special products on request	15
Single-phase cores	16
Three-phase cores	20
Bobbins and tubes for C cores	22
Bobbins and tubes for three-phase cores	24
Mounting frames for 2 C cores	25
Accessories for mounting cut cores	26
Banding for cut cores	29
2 . Toroid-based assemblies	31
General information about toroid cores	32
Toroid cores	33
Boxes and accessories for toroid cores	34
Toroid cores - Boxes - Cupels - Accessories	36
3 . EI type lamination-based assemblies	37
General information on cut lamination	38
Single/three-phase EI laminations	40
Various products for EI mounting	41
Bobbins	48
Fixing bars	53
EI fixing accessories	54
Boxes for EI laminations	58
4 . UI-M-EE type lamination-based assemblies	59
UI laminations and EE laminations	60
Various products for UI-M-EE mounting	61
Open slot bobbins	69
5 . Ferrite core-based assemblies	71
General information about ferrite materials	72
Various products for ferrite core mounting	75
6 . All types of accessories	79
Accessories, pins and terminals	80
Crimp terminals - C.I pins	84
Adhesive tapes	86
Insulating material	88
Insulating sleeves	90
Miscellaneous	92
Spacers - Nuts- Assembly products	93
General terms and conditions of sale	94

Isolectra partners

WEISSER - 3M - FERROXCUBE

→ Weisser

For over 60 years, the Weisser company has been a leading manufacturer of plastic precision parts such as bobbins, boxes and pins and has more than 4,500 items in its catalogue.

Thanks to its experience over the years, the company offers a comprehensive range for areas such as the electronics industry, telecommunications, the automotive sector, consumer electronics, medical technology, household appliances and engineering.

Continually observing the market, research and the development of the Weisser company make it possible to develop innovative products.

Since 1968, our privileged partnership with Weisser has allowed us to offer a wide range of solutions to meet your technical information and sampling needs in order to develop and validate your projects.

We can also carry out specific product developments upon request, please feel free to contact us.

You will find the list of materials available from Weisser on page 5.

Through our internet www.isolectra.fr website, you can access the Weisser Catalogue and their www.weisser.de website.

→ 3M

Founded in 1902, 3M (Minnesota Mining Manufacturing) designs, discovers, manufactures and markets solutions that facilitate and improve the lives of hundreds of millions of people around the world on a daily basis.

The group is structured around 6 key markets (Industry and Transport, Health, Signalling/Graphical and optical communication, Retail and Offices, Safety and Protection, Electronics and Communications) that share the same goal: innovating to develop more effective and more convenient products that are at the cutting edge of technology.

For 3M, innovation also means the desire to always satisfy and serve its customers, every day, while respecting its commitments and values.

Since 1987, our privileged partnership with 3M has allowed us to offer a wide range of solutions to meet your technical information and sampling needs in order to develop and validate your projects.

Through our internet www.isolectra.fr website, you can access the 3M Catalogue and their www.3mfrance.fr website.

→ Ferroxcube

Through its legacy of Philips Magnetic Components, Ferroxcube offers a wide range of soft ferrites, accessories and products to suppress electromagnetic and noise interference.

Always attentive to the market and changes in technological requirements, Ferroxcube puts emphasis on research and development, the aim being to support electronic markets by offering products that combine product miniaturisation while increasing their functionalities.

The main objective of the Ferroxcube company's quality approach is to maintain a high quality of its components and the best possible service for its customers.

It implements total quality control and promotes a partner relationship with its customers and suppliers.

RoHS

Ferroxcube guarantees that none of its products contain hazardous materials as described in the 2002/95/EC et 2003/11/EC directives from the European Parliament and Council of 27 January 2003 and 6 February 2003 "about restricting the use of certain hazardous substances in electrical and electronic equipment"

For over 30 years, our partnership with the Ferroxcube company has resulted in us being the main distributor of their products in France.

Through our internet www.isolectra.fr website, you can access the Ferroxcube Catalogue and their www.ferroxcube.com website.

→ Other

In order to propose an extended line, Isolectra also works with the following partners:

- **Cartoplast**, for an extension to the bobbin line. Their products

can be viewed on their web site: www.cartoplastsr.it

- **Chang Sung Corporation**, for toroids and powder cores. Their products can be viewed on their web site: www.changsung.com

COMMENT

This catalogue does its best to present our complete product line, nevertheless it is not exhaustive, we also propose standard or to measure amorphous cores, multiple accessories, epoxying, grinding or gluing of ferrite units, the cutting of insulator forms, copper strips, etc.

Please get in touch with your usual sales assistant or send your request to contact@isolectra.fr

Short designation	Chemical designation	Brand name	Supplier	UL-Certificate No.		Self-extinguishing properties		Glow wire test			Comparative tracking index	Insulation class	Notes
								IEC 695-2-1	IEC GWIT	IEC GWFI			
							acc. UL 94				acc. IEC 60112	acc. IEC 85	
PA 6	Nylon 6 (B-Polyamide)	Durethan BKV 30H 3.0	Lanxess	E 245249	12.12.2012	94-HB		700 (0.80)	750 (0.75)	700 (0.75)	475	B (130°)	2
		Durethan BG30 X	Lanxess	E 245249	30.11.2012	94-HB		650		650 (2.0)	400	B (130°)	1
		Zytel 73G30L	Du Pont	E 41938	10.03.2004	94-HB		700			400	B (130°)	2
		Bergamid B700G/Gk30	Poly One	E 76261	04.10.2011	94-HB		650			500	B (130°)	1
PA 4.6	Nylon 4.6	Stanyl TW 200 F6	DSM	E 47960	27.07.2007	94-HB				300			
PA 6.6	Nylon 6.6 (A-Polyamide)	Durethan AKV 30H 3.0	Lanxess	E 245249	12.12.2012	94-HB		650 (0.80)	725 (0.75)	700 (0.75)	500	B (130°)	2
		Ultramid A3X2G5	BASF	E 41871	19.01.2012	94-V0	(0.80)	960	725 (0.82)	960 (0.82)	550	B (130°)	2
		Ultramid A3X2G7	BASF	E 41871	27.03.2012	94-V0	(0.75)	960	775 (0.75)	960 (0.75)	600	B (130°)	2
		Bergamid A700G30H	Poly One	E 76261	05.12.2012	94-HB		650			500	B (130°)	2
PA 6.6/6	Nylon 6.6/6 (Copolymer)	Zytel FR 72G25 V0	Du Pont	E 41938	31.05.2012	94-V0	(0.50)	960			325	B (130°)	2
PBT	Polyethylene-terephthalate	Ultradur B4300G6	BASF	E 41871	05.12.2012	94-HB		650			375	B (130°)	2
		Arnite TV4 261	DSM	E 47960	30.11.2011	94-HB		650			400	B (130°)	2
		Pocan B 4239	Lanxess	E 245249	18.10.2010	94-V0	(0.8)	960	725 (0.8)	960 (0.8)	275	F (155°)	2
		Crastin SK-645FR	Du Pont	E 41938	21.11.2003	94-V0	(1.50)	960			250	F (155°)	2
PET	Polyethylene-terephthalate	Rynite FR 530L	Du Pont	E 41938	18.06.2012	94-V0	(0.35)	960	800 (0.75)	960 (0.75)	250	H (180°)	2
PPS	Polyphenylen-sulfide	Fortron 1140 L4	Ticona	E 107854	04.11.2011	94-V0	(0.38)	960			125	200 (200°)	
LCP	Liquid crystal polymer	Vectra E130	Ticona	E 83005	20.11.2003	94-V0	(0.38)	960			175	220 (220°)	
PEEK	Polyetherether-ketone	Victrex 150 GL 30	Victrex	E 161131	19.11.2012	94-V0	(0.75)	960		960 (2.0)	150		

This information and dates are taken from the recently available documents of the respective supplier.
Issue: 01/2014

Product families

TYPES OF ASSEMBLIES

C CORE-BASED ASSEMBLIES

11 · 36

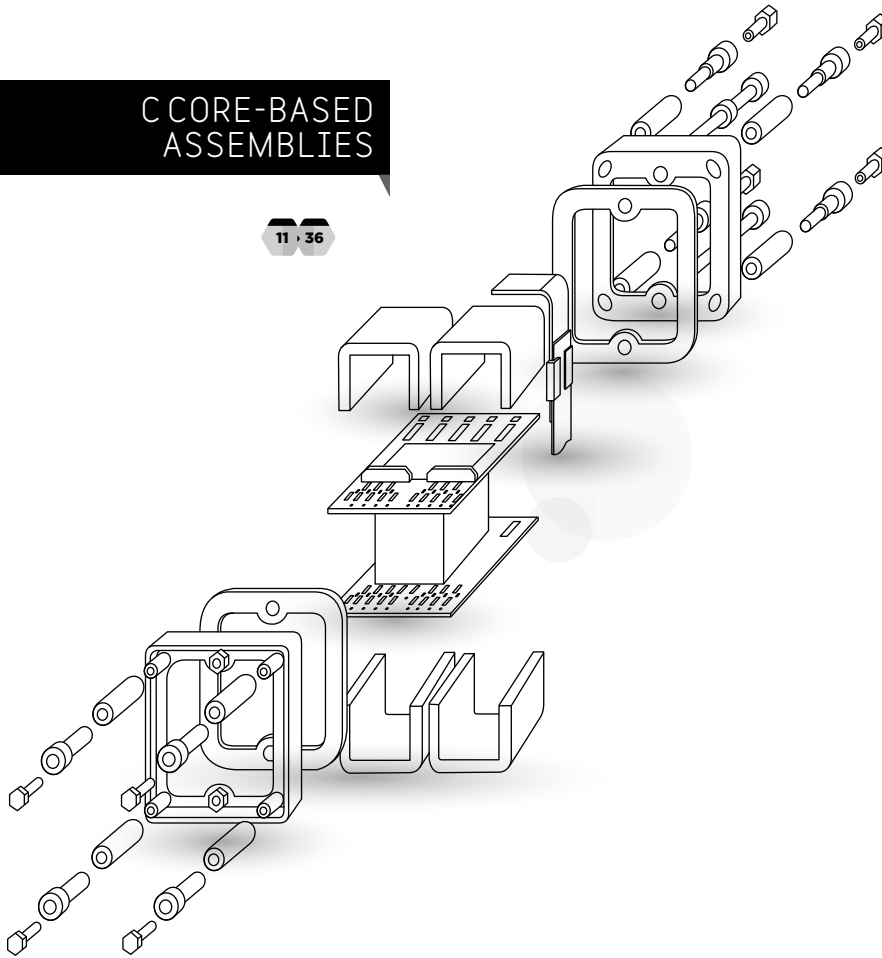

TOROIDS

31 · 36

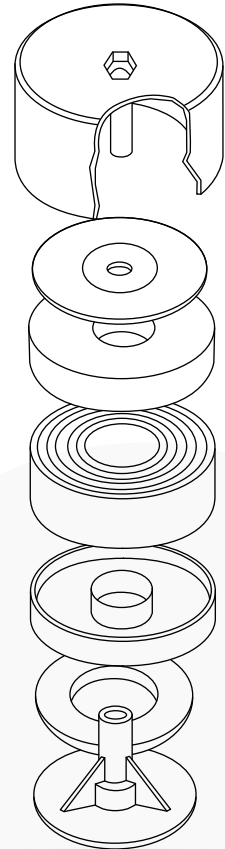

EI TYPE LAMINATION-BASED ASSEMBLIES

37 · 58

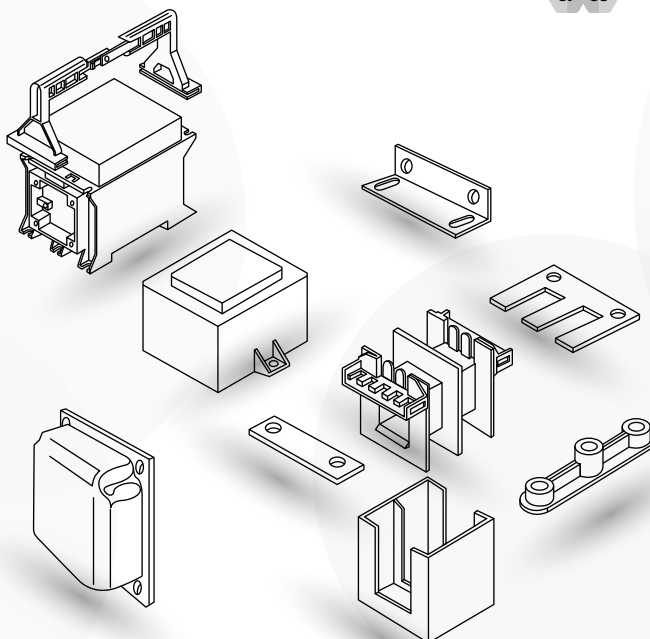

UI-M-EE TYPE
LAMINATION-BASED
ASSEMBLIES

59 · 70

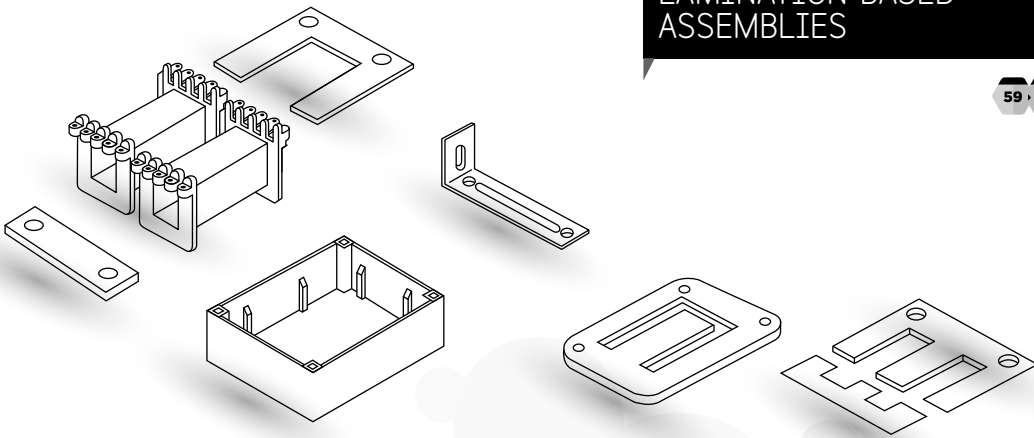

FERRITE
CORE-BASED
ASSEMBLIES

71 · 78

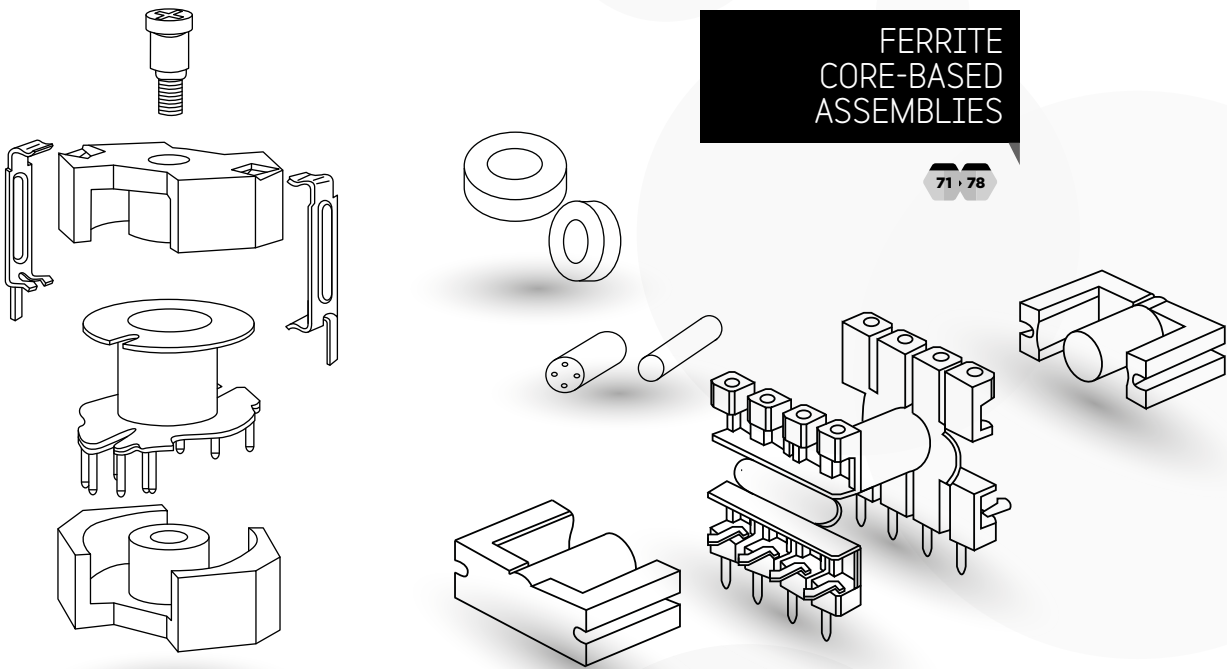

ALL TYPES OF ACCESSORIES

79 · 93

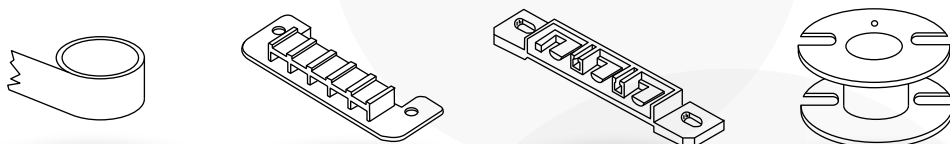

Product families

FA/SU/SM/SE TYPE SINGLE-PHASE/THREE-PHASE ROLLED SHEET METAL-BASED ASSEMBLIES

SINGLE-PHASE CORES
IN ACCORDANCE WITH
NFC 93326 / DIN 41309

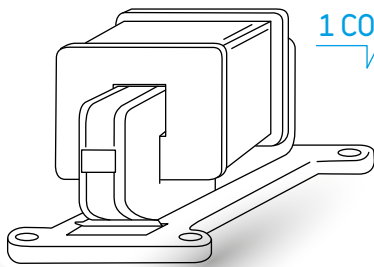

1 CORE MOUNTING

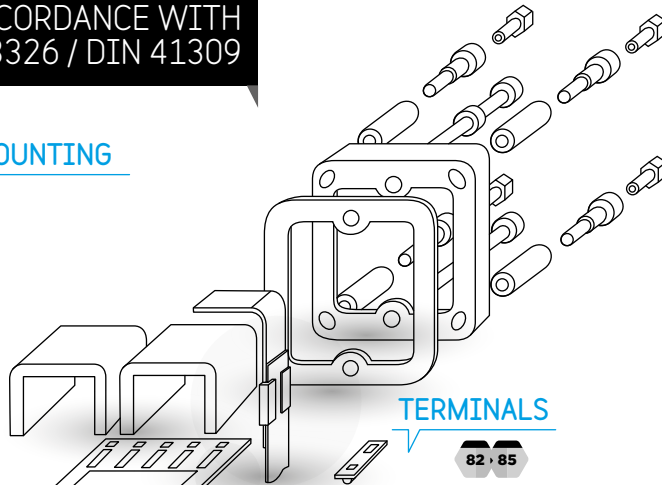

TERMINALS

82 · 85

ADHESIVES

86 · 89

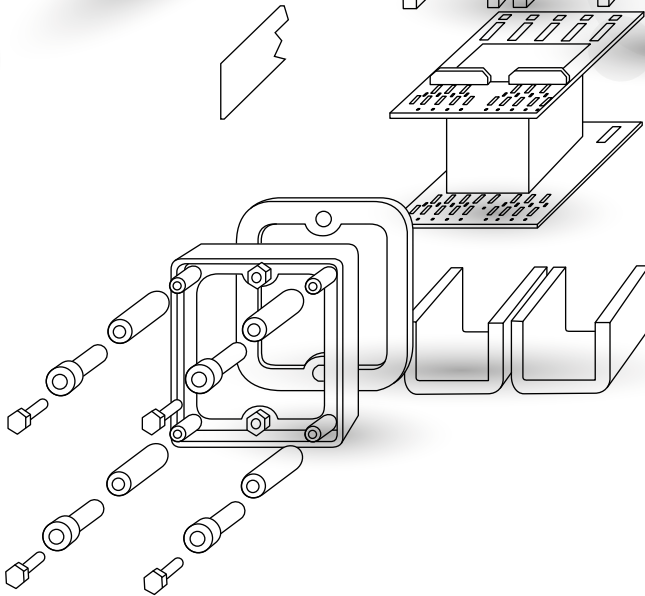
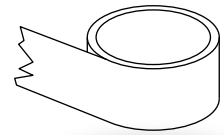

FRAMES

25 · 27

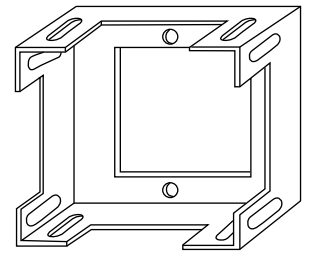
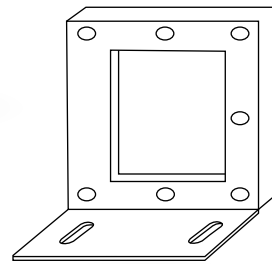

PLATE

27

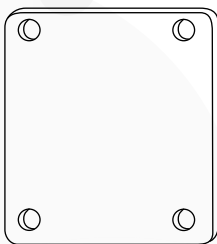

BOBBINS

22 · 24

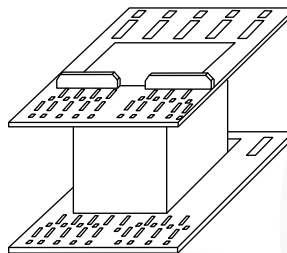

CORES

FA	16 · 17
SE - SM	18
SU	19

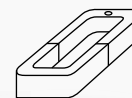

BANDING

28 · 30

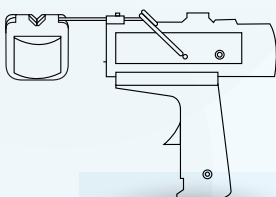

12 · 13

Technical information regarding calculations and recommendations for designing lamination core-based transformers.

THREE-PHASE CORES
IN ACCORDANCE WITH
NFC 93 326 / DIN 41309

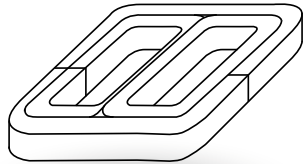

FA	20
S3U	21

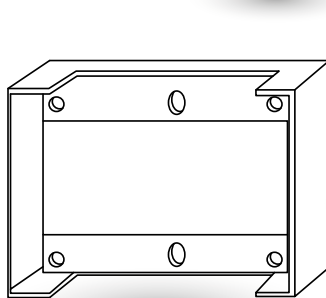
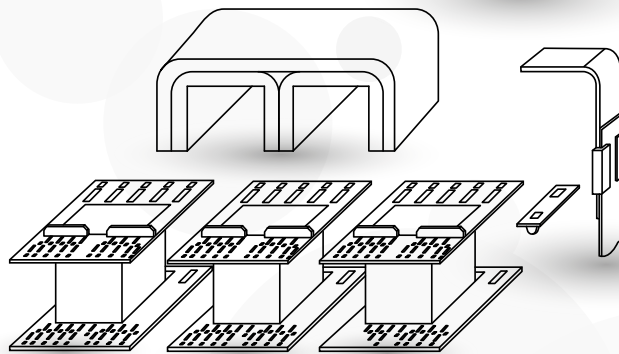
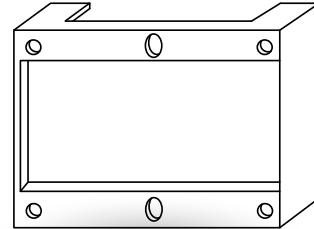

25, 27

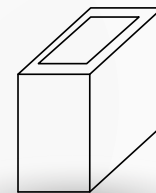
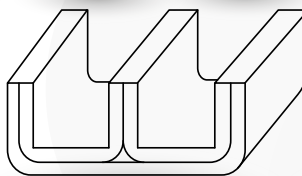

24



SINGLE-PHASE
THREE-PHASE

14, 19



BOBBINS

22, 24



FIXING
BRACKET

25, 27



BANDING

28, 30



TERMINALS

82, 85



INSULATORS
ADHESIVES
SHIELDING

86, 89

Product families

FA/SU/SM/SE TYPE SINGLE-PHASE/THREE-PHASE ROLLED SHEET METAL-BASED ASSEMBLIES

SINGLE-PHASE CORES
IN ACCORDANCE
WITH DIN

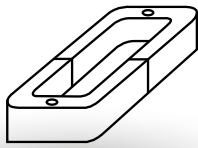

SE	18
SM	18
SU	19

HORIZONTAL
MOUNTING

VERTICAL
MOUNTING

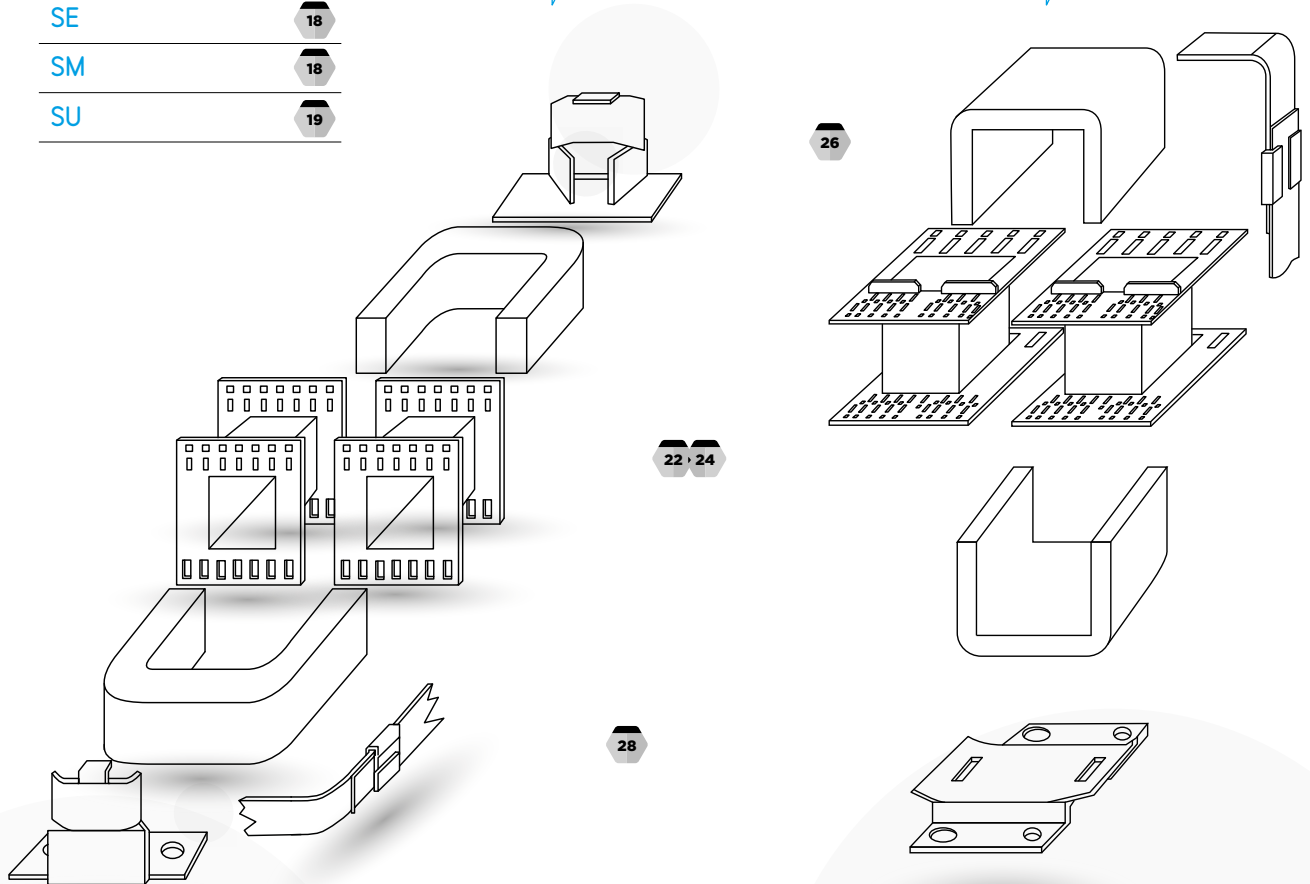

	SINGLE-PHASE THREE-PHASE	14, 19		BANDING	28, 30
	BOBBINS	22, 24		TERMINALS	82, 85
	FIXING BRACKET	25, 27		INSULATORS ADHESIVES SHIELDING	86, 89



Core-based assemblies

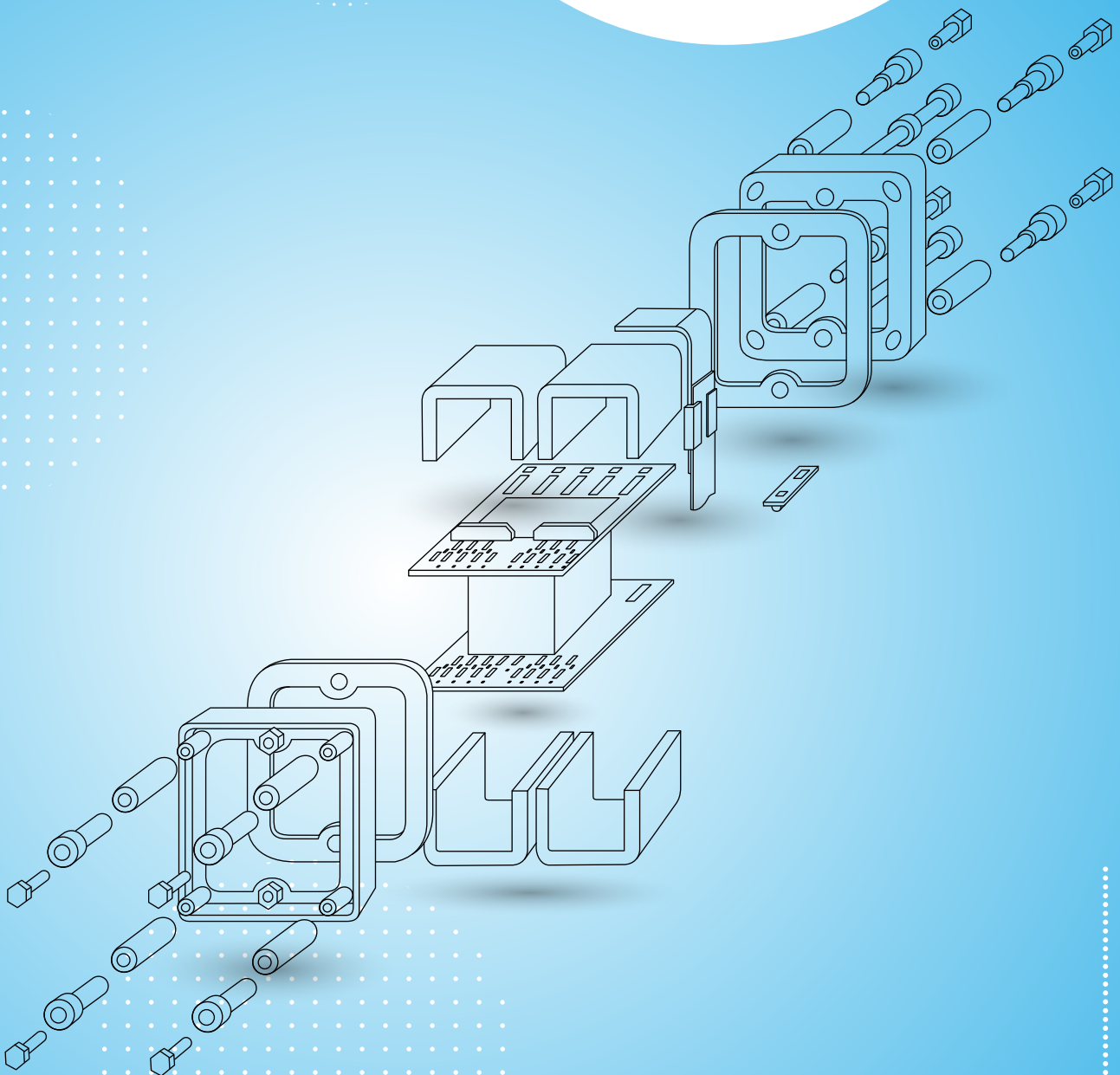

Core-based assemblies

GENERAL INFORMATION ABOUT SINGLE-PHASE CUT CORES

→ Equivalence list

C.E.I IEC 329 Q	United Kingdom DEF 5193 BS 5347/HWR	Germany DIN 41309 SG	France UTE C.93325	C.E.I IEC 329 Q	United Kingdom DEF 5193 BS 5347/HWR	Germany DIN 41309 SG	France UTE C.93325
1.1	3/4	27/7	D 06	8.1	50/14	89/22	V 22
2.1	4/5	33/7	F 08	8.2	50/18	89/29	V 29
3.1	5/6	41/9	H 10	8.3	50/24	89/38	V 38
4.1	7/6	48/9	J 10	8.4	50/32	89/51	V 51
5.1	10/8	54/13	Q 13	9.1	70/12	108/19	X 19
5.2	10/12	54/19	Q 19	9.2	70/18	108/29	X 29
5.3	10/16	54/25	Q 25	9.3	70/24	108/38	X 38
5.4	10/24	54/38	Q 38	9.4	70/32	108/51	X 51
6.1	30/8	70/13	T 13	10.1	90/16	127/25	Z 25
6.2	30/12	70/19	T 19	10.2	90/24	127/38	Z 38
6.3	30/16	70/25	T 25	10.3	90/32	127/51	Z 51
6.4	30/20	70/32	T 32	10.4	90/44	127/70	Z 70
7.1	40/12	76/19	U 19	11.1	110/20	165/32	AD 32
7.2	40/16	76/25	U 25	11.2	110/32	165/51	AD 51
7.3	40/20	76/32	U 32				
7.4	40/24	76/38	U 38				

→ Magnetising power and losses for cut cores

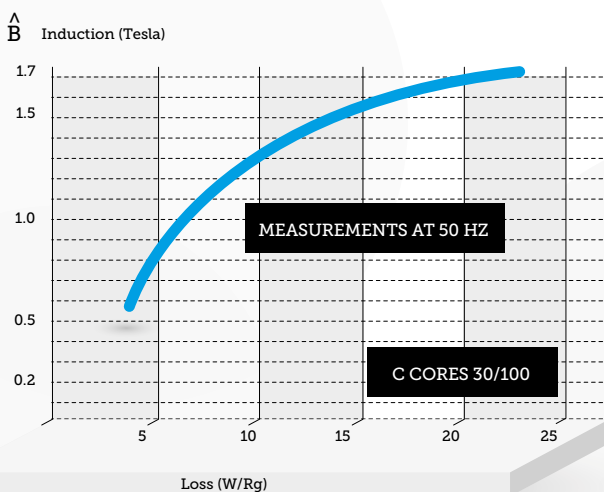
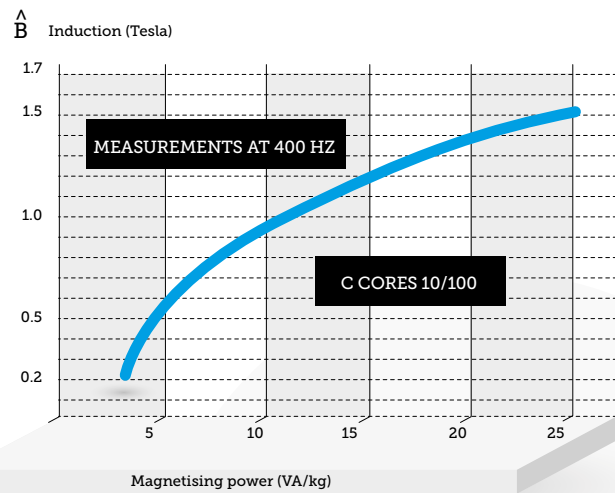
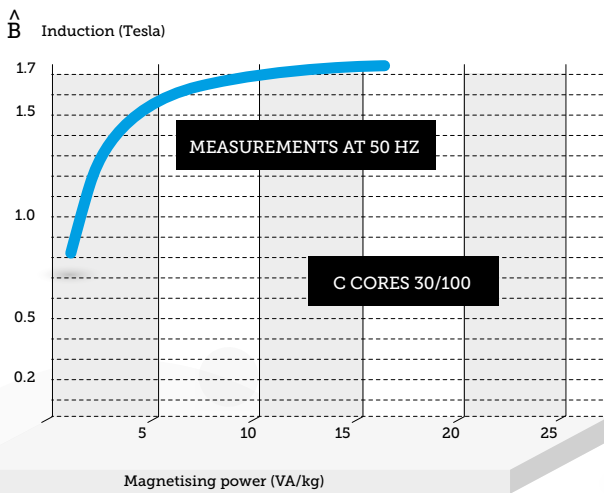

→ General information

INITIAL MATERIAL CHARACTERISTICS

The general characteristics are communicated by the metallurgists and measured by the Epstein method on a circular core without an air gap that is non-impregnated and suitably proportioned. They are given as an indication and, for "grain oriented" sheet metal, represent an ideal that manufacturing operations (rolling, impregnation, sawing, etc) tend to reduce.

PHYSICAL CHARACTERISTICS

Iron-silicon alloy at 3.5% Si
Density: 7.65
Resistivity: 48 m Ω cm
Curie point: 746°C

MAGNETIC CHARACTERISTICS

Specific active losses in W/Kg

- 30/100 strip
at 50 Hz for B = 1 Tesla ...: 0.6
at 50 Hz for B = 1.5 Tesla ...: 1.1
at 25 Hz for B = 1 Tesla ...: 0.8

- 10/100 strip
at 400 Hz for B = 1 Tesla ...: 6.5
at 400 Hz for B = 1.5 Tesla ...: 15

- High induction
B = 1.83 Tesla for H = 7.95 A/cm
B = 2.03 Tesla for H tending to infinity.

- Excitation field (rms)
H = 0.35 A/cm for B = 1.5 Tesla

COMMENT

The majority of the information given in this brochure is in accordance with the NFC 93325 standard.
This is a national transposition of the IEC 329 publication of 1971.

→ Technical vocabulary

ELECTRICAL AND MAGNETIC QUANTITIES

F	= Frequency	Hz
U _{2s}	= Specific voltage for B and F fixed	mV/turn
PLS	= Specific active losses	W/Kg
Q _s	= Total specific reactive power	VAR/Kg
S _s	= Total specific excitation power	VA/Kg
PL	= Total active losses B and F fixed	W
B	= Maximum induction	T
H	= Excitation field (rms)	A/cm
S	= Total excitation power	VA
P _t	= Transmissible power (indicative)	VA

PHYSICAL QUANTITIES

LFI	= Length of the average force line	cm
mFe	= Maximum iron mass	g or Kg
AFe	= Minimum actual section	cm ²
α	= coefficient of expansion	$\frac{\text{Actual section}}{\text{Apparent section}}$

CONVENTIONAL PARAMETERS

Temperature class: The magnetic cores presented in this catalogue are class A, that is to say, supporting variations from -55°C to +105°C without altering their characteristics.

IDENTIFICATION OF STANDARDISED CORES

The designation of cores is constituted as follows:

- a first letter indicates the type of material "F" for iron - silicon grain oriented crystals
- a second letter indicates the temperature class "A"
- a two-digit number for the strip thickness expressed in hundredths of millimetres
- a letter "E" if it is a three-phase core, nothing for single-phase
- one or two letters characteristic of the series
- a two-digit number indicating the approximate width of the strip in millimetres.

EXAMPLE: FA30EC19

"Grain oriented cut silicon-iron magnetic core - Temperature class "A"
Strip thickness 30/100 mm - Three-phase use - Strip width 19 mm"

→ Identification

Cut cores

Sheet metal 0.30 - 0.10 - 0.05

"A" quality: Standard catalogue

"C" quality: Reduced air gap, customer-specific electrical values or reduced magnetizing currents

"Rough cut" quality: Applications using a significant air gap of the order of mm

MARKING

30/100	= red dot
10/100	= white dot
5/100	= green dot
A quality	= 1 dot
C quality	= 2 dots

Core-based assemblies

CALCULATION METHOD FOR C CORE-BASED TRANSFORMERS

→ Choice of core

Industrial transformers are characterised by the following main data:

a) U_1 primary voltage, b) U_2 secondary load voltage, c) PS2 power at the secondary terminals, d) frequency f .

→ Basic formulas for calculating the preliminary design of a transformer

1 Power output

$S_1 \times S_f \times k$ (according to table 1)

S_1 = Iron section (cm²)

S_f = window area (cm²)

K = 1.7 to 2.2 for an induction of 17,000 gauss

(2.2 for very low power transformers to 1.7 for 1 kW transformers)

2 Output (η)

60% to 96% (according to table 2)

3 Number of primary turns (N_1)

$U_1 \times Nv$

$Nv = 4,44 \times f \times S \times B_{max} \times 10^{-8}$

f (Hz) S (cm²) B (Gauss)

4 Number of secondary turns (N_2)

$N_2 = U_2 \times Nv$

To obtain the secondary load voltage, a certain number of turns compensating for the ohmic drop must be added to the primary and secondary. One can, with a reasonable approximation, increase the number of secondary turns by a percentage equal to $100 - \eta/2$ where η is the output as a %.

5 I_1 current

$P_{s2} / (U_1 \times \eta)$

P_{s2} = secondary power in VA

U_1 = primary voltage (V)

η = planned output in the proposed design

6 Current density

Δ (A/mm²) (according to table 1)

The current density is chosen according to the elevation allowed for the wire temperature. In general, 60°C.

7 Wire diameter

$d = 1.13 \sqrt{I / \Delta}$ (mm)

8 Winding thickness (E_1)

$E_1 = F - 3e_c$

Approximate empirical value, making it possible to calculate the average turn.

9 Length of the average turn

$Lm = 2(2E + D + 6e_c) + 3E_1$ (approximate value)

E and D according to table No. 1

e_c is an absolute empirical value used to compensate for the calculation of the wall thicknesses and the core/bobbin mechanical gap.

10 Ohmic resistance of windings

$R = \rho \cdot Lt/S$

Lt = total length of the winding in metres ($Lm \times N_1 + Lm \times N_2$), where Lm is the length of the average turn and N_1, N_2 are the number of turns in each winding

ρ = copper resistivity (0.0175 Ω mm²/m). At 60°C it is 0.021 Ω mm²/m.

S = wire section in mm²

R = resistance in Ω

11 Total voltage drop calculation

$U_t = R_1 \cdot I_1 \times (U_2/U_1) + R_2 \cdot I_2$ (by eliminating the self immediately)

12 Total losses in the transformer's copper

$= R_1(\text{hot}) \times I_1^2 + R_2(\text{hot}) \times I_2^2$

= primary losses + secondary losses

→ Calculation example for a transformer

Transformer characteristics

To calculate a single phase PS transformer = 120 VA, primary voltage. $U_1 = 220$ volts, secondary voltage $U_2 = 100$ V (load). Frequency 50 Hz.

1 Choice of core

Table 1: U38 or V22 circuits (30/100). We will choose the U38 which are smaller and therefore more beneficial.

2 Output (η) (table 2)

The minimum output for this power is 85%.

3 Number of primary turns (N_1) (table 1)

3.74 turns per volt for the U38 circuit. The number of primary turns is therefore $N_1 = 220 \times 3.74 = 823$ turns.

4 Number of secondary turns (N_2)

Number of secondary turns: $N_2 = U_2 \times$ number of turns per volt
 $N_2 = 100 \times 3.74 = 374$ turns. To obtain the number secondary load turns, N_2 needs to be increased by a percentage "a" or: $100 - \eta/2$, therefore $a = (100 - 85) / 2 = 7.5\%$ in which $N_2 = 374 \times 1.075 = 402$ turns

5 Calculation of currents (I_1/I_2)

Primary current: $I_1 = PS / U_1 \times \eta = 120 / (0.85 \times 220) = 0.64$ A

Secondary current: $I_2 = PS / U_2 = 120/100 = 1.2$ A

6 Current density Δ (table 1)

3.6 A/mm²

7 Diameter of wires

$d = 1.13 \cdot \sqrt{I/\Delta}$ ($1.13 \sqrt{0.64 / 3.6} = 0.45$ mm) for the primary wire and $1.13 \cdot \sqrt{1.2 / 3.6} = 0.65$ mm for the secondary wire.

8 Winding thickness ($E_1 = F - 3e_c$)

$E_1 = 1.9 - (3 \times 0.2) = 1.3$ cm

9 Length of the average turn

$Lm = 2(2E + D + 6 \times 0.2) + 3E_1$
 $= 2(2 \times 0.95 + 3.8 + 1.2) + 3 \times 1.3 = 17.7$ cm

10 Resistance of the winding (R_1/R_2)

Calculating the total length of wire for the windings, or $L_1 = Lm \times N_1$ (or 145 m for the primary and 71.3 m for the secondary).

The resistance is calculated by the formula $R = \rho \cdot L/S$ ($\rho = 0.0175 \Omega$ mm²/mm)

($R_1 = 15.95$ ohms for the primary and $R_2 = 3.81$ ohms for the secondary)

11 Copper losses (P_c)

$P_c = R_1 \times I_1^2 + R_2 \times I_2^2 = 6.76 + 5.62 = 12.01$ W

12 Iron losses (table 1)

For two U38 circuits: 2.1 Watts

13 Output verification (η)

$\eta = PS/(PS + P_c + P_f) = 120/(120 + 2.1) = 0.89$ (instead of the 85% announced)

We have found an output of 89% instead of 85%. Under these conditions, the primary current will be reduced to $I_1 = 120 / (0.89 \times 220) = 0.6$ A instead of 0.64 A.

In possession of the R_1 and R_2 exact resistances as well as the I_1 and I_2 currents, we can accurately calculate the total voltage drop (ohmic) of the transformer and correct the exact number of secondary turns.

The total voltage drop is $(I_1 \times R_1 \times U_2/U_1) + R_2 \times I_2 = 8.9$ V instead of 7.5V. The number of secondary turns will therefore be 420 rather than 402.

→ Table 1

FA30 core references	Maximum power transmitted	Overall dimensions of the transformer	Iron section	Length of the force line	Turns per Volts	Intensity in the copper	Pow./volume ratio	Total losses	Apparent power	Window width F	E	D	e_c
(30/100)		A x B x C	cm ²	cm		Δ/mm ²	Watt/cm ³	W	VA	cm	cm	cm	cm
Q 13	20	54x59x44	1.92	12.78	13.65	5.9	0.146	0.42	4.6	1.27	0.79	1.27	0.15
Q 19	29	54x59x50	2.88	12.78	9.4	5.1	0.182	0.62	6.8	1.27	0.79	1.9	0.15
Q 25	38	54x59x56	3.84	12.78	7.12	4.5	0.214	0.82	9	1.27	0.79	2.5	0.15
Q 38	58	54x59x69	5.76	12.78	4.59	3.8	0.232	1.24	14.4	1.27	0.79	3.8	0.15
T 13	41	71x73x50	2.3	16.54	10.95	5.4	0.168	0.66	6.2	1.59	0.95	1.27	0.15
T 19	60	71x73x56	3.44	16.54	7.46	4.7	0.207	0.98	9.4	1.59	0.95	1.9	0.15
T 25	75	71x73x62	4.6	16.54	5.69	4.1	0.242	1.28	12.6	1.59	0.95	2.5	0.15
T 32	95	71x73x69	5.74	16.54	4.45	3.8	0.266	1.6	15.8	1.59	0.95	3.2	0.15
U 19	68	77x79x65	3.44	18.14	7.48	4.7	0.174	1.06	10	1.9	0.95	1.9	0.15
U 25	88	77x79x71	4.6	18.14	5.69	4.1	0.204	1.4	13.4	1.9	0.95	2.5	0.15
U 32	110	77x79x78	5.74	18.14	4.45	3.8	0.23	1.76	16.6	1.9	0.95	3.2	0.2
U 38	145	77x79x84	6.9	18.14	3.74	3.6	0.264	2.1	20	1.9	0.95	3.8	0.2
V 22	136	89x97x76	5.36	21.06	4.98	4	0.212	1.9	17.2	2.2	1.3	2.2	0.2
V 29	180	89x97x83	6.9	21.06	3.77	3.6	0.252	2.44	22	2.2	1.3	2.9	0.2
V 38	230	89x97x92	9.2	21.06	2.88	3.3	0.29	3.26	29.4	2.2	1.3	3.8	0.2
V 51	300	89x97x103	12.26	21.06	2.15	2.85	0.33	4.36	39.2	2.2	1.3	5.1	0.2
X 19	220	108x123x87	5.74	25.86	4.18	3.9	0.193	2.5	21	2.9	1.6	1.9	0.2
X 29	330	108x123x97	9.08	25.86	3.18	3.4	0.256	3.96	33.4	2.9	1.6	2.9	0.2
X 38	440	108x123x106	11.34	25.86	2.34	3	0.314	5	42.2	2.9	1.6	3.8	0.2
X 51	580	108x123x119	15.32	25.86	1.74	2.6	0.354	6.66	56.4	2.9	1.6	5.1	0.3
Z 25	430	127x147x105	9.2	30.68	3	3.3	0.216	4.74	38.2	3.5	1.9	2.5	0.2
Z 38	710	127x147x118	13.8	30.68	1.97	2.7	0.322	7.12	57.4	3.5	1.9	3.8	0.3
Z 51	900	127x147x131	18.46	30.68	1.47	2.5	0.37	9.52	76.8	3.5	1.9	5.1	0.3
Z 70	1200	127x147x150	25.3	30.68	1.07	2.3	0.427	13.06	105	3.5	1.9	7	0.4
AD 32	1200	164x189x130	15.36	40.23	1.78	2.6	0.29	10.4	78.8	4.5	2.5	3.2	0.4
AD 51	1900	164x189x149	24.52	40.23	1.12	2.4	0.41	16.6	125.6	4.5	2.5	5.1	0.4
AJ 32	2000	209x240x150	18.46	49.4	1.4	2.5	0.265	14.6	88	5.6	3.2	3.2	0.4
AJ 51	3200	209x240x170	31	49.4	0.83	2	0.31	23.4	140	5.6	3.2	5.1	0.4
AP 32	3500	209x240x190	24.32	61.7	1.1	2.3	0.22	22.8	136.8	7	4	3.2	0.4
AP 51	5500	260x300x210	38.76	61.7	0.7	1.7	0.33	36.4	218.4	7	4	5.1	0.4

→ Table 2

Power	Output
VA	%
25	76
50	84
100	85
200	86
300	88
400	90
500	92
700	91
1000	92
1300	92
1500	94
2000	95

→ Table 3

PS	e_c^*
VA	cm
1 to 10	0.05
10 to 100	0.15
100 to 500	0.2
500 to 1000	0.3
1000 to 3000	0.4

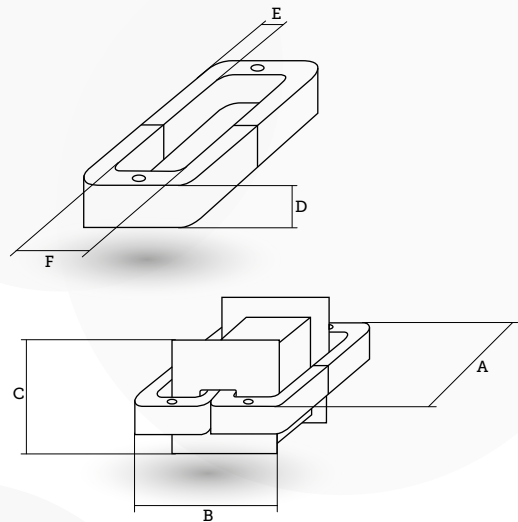

→ Special products on request

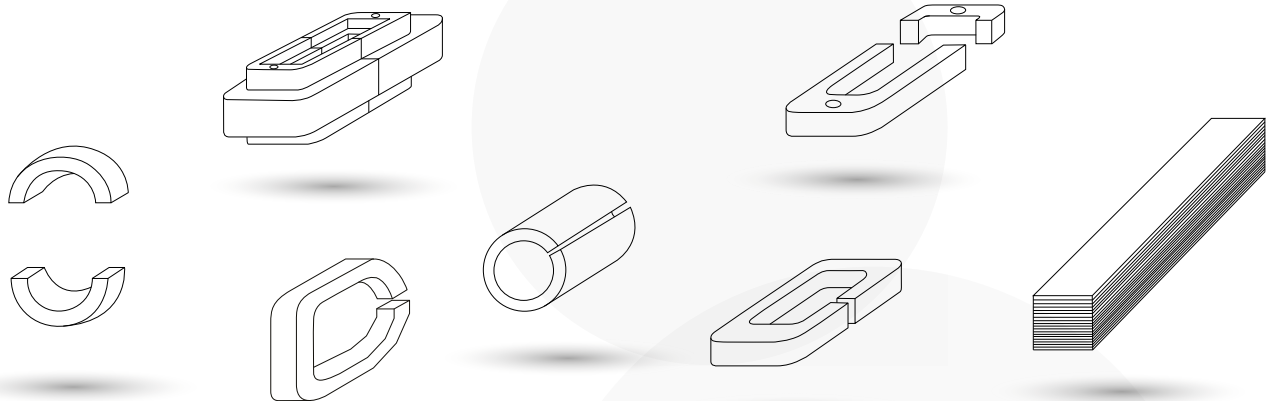

Core-based assemblies

SINGLE-PHASE CORES

→ Single-phase cores C type (FA30) in accordance with NFC 93 326

"A" quality ("C quality with a reduced air gap on request")

The electrical characteristics are given for $B = 1.7$ T and $F = 50$ Hz.

The transmissible powers P_t are given as an indication and for a single core.

Sheet metal 30/100

Type FA30**	Mechanical characteristics							Physical characteristics				Electrical characteristics			(1 core)
	A max.	B max.	D 0+0.8	F min.	G min.	E min.	R max.	mFe g	AFe cm ²	LFI cm	U2S mV/sp	PL W	S VA	Pt VA	Code
5 x 5	15	21	5	5	11	5	1	10	0.237	4.9	8.8	0.022	0.25	0.4	D30002
D 06	21.3	29.2	6.4	6.4	14.3	6.4	1	17.5	0.39	6.3	15	0.04	0.4	1	D30003
D 6-2	21.3	43.2	6.4	6.4	28.6	6.4	1	25.3	0.39	9.1	15	0.06	0.6	1.5	D30053
D 12	21.3	29.2	12.4	6.4	14.3	6.4	1	35	0.78	6.3	30	0.08	0.8	2	D30004
F 08	26	35.4	8	7.9	17.5	7.9	1	34.7	0.608	7.5	23	0.07	0.7	1.5	D30005
F 8-2	26	52.4	8	7.9	35	7.9	1	50.4	0.608	10.9	23	0.1	1	2	D30054
F 16	26	35.4	16	7.9	17.5	7.9	1	69.4	1.216	7.5	46	0.14	1.4	3	D30006
H 10	32	44.4	10	9.5	22.2	9.5	1	67.5	0.95	9.4	36	0.15	1.1	3	D30007
H 10-2	32	66.4	10	9.5	44.4	9.5	1	99	0.95	13.8	36	0.22	1.6	4.5	D30055
H 20	32	44.4	20	9.5	22.2	9.5	1	135	1.9	9.4	72	0.3	2.2	6	D30008
J 10	33	51.4	10	11.1	28.6	9.5	1	78.5	0.95	11	36	0.17	1.2	5	D30009
J 10-2	33	80.4	10	11.1	58	9.5	1	120	0.95	16.8	36	0.26	1.9	6.5	D30060
J 20	33	51.4	20	11.1	29	9.5	1	157	1.9	11	72	0.34	2.4	10	D30010
Q 13	30.6	56.4	12.7	12.7	38.1	7.9	1.5	94	0.96	12.78	36.3	0.21	2.3	10	D30011
Q 19	30.6	56.4	19	12.7	38.1	7.9	1.5	141	1.44	12.78	54.4	0.31	3.4	15	D30012
Q 25	30.6	56.4	25.4	12.7	38.1	7.9	1.5	187	1.92	12.78	72.6	0.41	4.5	20	D30013
Q 38	30.6	56.4	38.1	12.7	38.1	7.9	1.5	281	2.88	12.78	109	0.62	6.8	30	D30014
T 13	36.9	73	12.7	15.9	50.8	9.5	1.5	145	1.15	16.54	43.5	0.32	3.1	20	D30015
T 19	36.9	73	19	15.9	50.8	9.5	1.5	218	1.72	16.54	65	0.48	4.7	30	D30016
T 25	36.9	73	25.4	15.9	50.8	9.5	1.5	291	2.3	16.54	78	0.64	6.3	40	D30017
T 32	36.9	73	31.7	15.9	50.8	9.5	1.5	363	2.87	16.54	108	0.8	7.9	45	D30018
T 44.5	36.9	73	44.4	15.9	50.8	9.5	1.5	509	4.01	16.54	151.3	1.3	11.1	70	D30065
T 51	36.9	73	50.8	15.9	50.8	9.5	1.5	581	4.58	16.54	172.8	1.48	12.7	75	D30064
U 19	40.1	79.4	19	19	57.2	9.5	3	239	1.72	18.14	65	0.53	5	35	D30019
U 25	40.1	79.4	25.4	19	57.2	9.5	3	319	2.3	18.14	87	0.7	6.7	44	D30020
U 32	40.1	79.4	31.7	19	57.2	9.5	3	398	2.87	18.14	108	0.88	8.3	55	D30021
U 38	40.1	79.4	38.1	19	57.2	9.5	3	478	3.45	18.14	130	1.05	10	70	D30022
U 51	40.1	79.4	50.8	19	57.2	9.5	3	637	4.58	18.14	173	1.4	13.3	90	D30066
V 22	49.6	92.1	22.2	22.2	63.5	12.7	3	432	2.68	21.06	101	0.95	8.6	65	D30023
V 29	49.6	92.1	28.6	22.2	63.5	12.7	3	553	3.45	21.06	130	1.22	11	90	D30024
V 38	49.6	92.1	38.1	22.2	63.5	12.7	3	739	4.6	21.06	174	1.63	14.7	115	D30025
V 51	49.6	92.1	50.8	22.2	63.5	12.7	3	989	6.13	21.06	232	2.18	19.6	150	D30026
V 70	49.6	92.1	69.8	22.2	63.5	12.7	3	1359	8.42	21.06	318	3	26.9	190	***
X 19	62.3	111.1	19	28.6	76.2	15.9	3	567	2.87	25.86	108	1.25	10.5	110	D30027
X 29	62.3	111.1	28.6	28.6	76.2	15.9	3	896	4.54	25.86	172	1.98	16.7	165	D30028
X 38	62.3	111.1	38.1	28.6	76.2	15.9	3	1138	5.75	25.86	217	2.5	21.1	220	D30029
X 51	62.3	111.1	50.8	28.6	76.2	15.9	3	1515	7.66	25.86	290	3.33	28.2	290	D30030
X 70	62.3	111.1	69.8	28.6	76.2	15.9	3	2082	10.54	25.86	398	4.58	38.6	390	D30068
X 102	62.3	111.1	101.6	28.6	76.2	15.9	3	3030	15.32	25.86	578	6.66	56.2	570	D30067
Z 25	75	130.2	25.4	34.9	88.9	19	3	1079	4.6	30.68	174	2.37	19.1	215	D30031
Z 38	75	130.2	38.1	34.9	88.9	19	3	1619	6.9	30.68	260	3.56	28.7	355	D30032
Z 51	75	130.2	50.8	34.9	88.9	19	3	2163	9.23	30.68	349	4.76	38.4	450	D30033
Z 70	75	130.2	69.8	34.9	88.9	19	3	2966	12.65	30.68	478	6.53	52.7	600	D30034
Z 102	75	130.2	101.6	34.9	88.9	19	3	4326	18.38	30.68	694	9.53	76.9	880	D30069
AD 32	97.2	169.9	31.7	44.4	114.3	25.4	3	2363	7.68	40.23	290	5.2	39.4	600	D30035

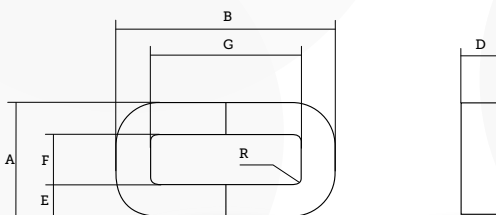

→ Single-phase cores C type (FA 10 - FA 30)

Type FA30 **	Mechanical characteristics							Physical characteristics				Electrical characteristics			(1 core)
	A max.	B max.	D 0+0.8	F min.	G min.	E min.	R max.	mFe g	AFe cm ²	LFI cm	U2S mV/sp	PL W	S VA	Pt VA	Code
AD 51	97.2	169.9	50.8	44.4	114.3	25.4	3	3773	12.26	40.23	463	8.3	62.8	950	D30036
AD 70	97.2	169.9	69.8	44.4	114.3	25.4	3	5179	16.88	40.23	637	11.4	86.2	1200	D30043
AD 83	97.2	169.9	82.5	44.4	114.3	25.4	3	6136	19.95	40.23	753	13.5	102.1	1400	D30044
AD 102	97.2	169.9	101.6	44.4	114.3	25.4	3	7546	24.57	40.23	927	16.6	125.6	1800	D30041
AJ 32	123	214	32	56	145	32	5	3650	9.73	49.4	367	7.3	44	1000	D30037
AJ 51	123	214	51	56	145	32	5	5820	15.5	49.4	585	11.7	70	1600	D30038
AJ 64	123	214	64	56	145	32	5	7300	19.46	49.4	734	14.6	87.6	2000	D30046
AJ 70	123	214	70	56	145	32	5	7990	21.28	49.4	804	16	96	2200	D30047
AJ 102	123	214	102	56	145	32	5	11640	31	49.4	1170	23.3	139.7	3200	D30045
AP 32	153	265	32	70	180	40	5	5700	12.16	61.7	459	11.4	68.4	1750	D30039
AP 51	153	265	51	70	180	40	5	9100	19.38	61.7	732	18.2	109.2	2750	D30040
AP 70	153	265	70	70	180	40	5	12490	26.6	61.7	1005	25	149.9	3750	D30049
AS 51	194.5	337	51	90	230	50	5	14500	24.2	78.8	914	29	174	5000	D30051
AS 70	194.5	337	70	90	230	50	5	19900	33.2	78.8	1253	39.8	238.8	6600	D30052
AS 100	194.5	337	100	90	230	50	5	28450	47.5	78.8	1794	56.9	341.4	9200	D30050
HB 32	249	333	32	115	196	64	5	12050	19.46	81.4	734	24.1	145	3800	D30058
HB 51	249	333	51	115	196	64	5	19200	31	81.4	1170	38.4	230	6000	D30059
HF 38	256	439	38	130	310	60	5	17450	21.7	106	819	34.9	209	5900	**
HG 38	336	519	38	130	310	100	5	32500	36.1	118.5	1363	65.5	390	10000	**
HJ 51	298	467	51	190	356	51	5	23350	24.7	124.4	932	46.7	280	7500	D30073
HK 51	400	569	51	190	356	102	5	52750	49.4	140.4	1865	106	633	16000	**

→ Single-phase CORES sheet metal type 10/100 in accordance with NF C93 326

The electrical characteristics are given for B = 1.5 T and F = 400 hz.

Type FA10 **	Mechanical characteristics							Physical characteristics				Electrical characteristics 1.5T			(1 circuit)
	A max.	B max.	D 0+0.8	F min.	G min.	E min.	R max.	mFe g	AFe cm ²	LFI cm	U2S mV/sp	PL W	S VA	Pt VA	Code
D 06	21	29.4	6.4	6.4	14.3	6.4	1	17.4	0.361	6.32	99	0.4	3	4	D31003
F 08	25.8	35.7	7.9	7.9	17.5	7.9	1	33.6	0.564	7.77	155	0.76	4.9	10	D31005
H10	30.6	43.7	9.5	9.5	22.2	9.5	1	61	0.836	9.53	223	1.34	7.3	23	D31007
J 10	32.1	50	9.5	11.1	28.6	9.5	1	71	0.836	11.13	223	1.57	7.6	34	D31009
Q 13	30.6	56.4	12.7	12.7	38.1	7.9	1.5	91	0.93	12.78	249	2.01	8.8	40	D31011
Q 19	30.6	56.4	19	12.7	38.1	7.9	1.5	137	1.39	12.78	373	3.01	13.2	60	D31012
Q 25	30.6	56.4	25.4	12.7	38.1	7.9	1.5	181	1.86	12.78	497	3.99	17.5	80	D31013
Q 38	30.6	56.4	38.1	12.7	38.1	7.9	1.5	273	2.79	12.78	745	6	26.3	120	D31014
T 13	36.9	73	12.7	15.9	50.8	9.5	1.5	141	1.11	16.54	298	3.09	11.4	80	D31015
T 19	36.9	73	19	15.9	50.8	9.5	1.5	211	1.66	16.54	445	4.65	17.2	120	D31016
T 25	36.9	73	25.4	15.9	50.8	9.5	1.5	282	2.23	16.54	595	6.21	22.9	160	D31017
T 32	36.9	73	31.7	15.9	50.8	9.5	1.5	352	2.78	16.54	742	7.75	28.6	180	D31018
U 19	40.1	79.4	19	19	57.2	9.5	3	232	1.66	18.14	445	5.1	17.8	140	D31019
U 25	40.1	79.4	25.4	19	57.2	9.5	3	309	2.23	18.14	595	6.81	23.8	176	D31020
U 32	40.1	79.4	31.7	19	57.2	9.5	3	386	2.78	18.14	742	8.5	29.6	220	D31021
U 38	40.1	79.4	38.1	19	57.2	9.5	3	464	3.34	18.14	893	10.2	35.6	280	D31022
V 22	49.6	92.1	22.2	22.2	63.5	12.7	3	419	2.59	21.06	693	9.2	29.5	260	D31023
V 29	49.6	92.1	28.6	22.2	63.5	12.7	3	536	3.34	21.06	893	11.8	37.8	360	D31024
V 38	49.6	92.1	38.1	22.2	63.5	12.7	3	717	4.46	21.06	1190	15.8	50.5	460	D31025
V 51	49.6	92.1	50.8	22.2	63.5	12.7	3	959	5.94	21.06	1586	21.1	67.4	600	D31026
X 19	62.3	111.1	19	28.6	76.2	15.9	3	550	2.78	25.86	742	12.1	34.7	440	D31027
X 29	62.3	111.1	28.6	28.6	76.2	15.9	3	869	4.4	25.86	1174	19.2	54.9	660	D31028
X 38	62.3	111.1	38.1	28.6	76.2	15.9	3	1104	5.57	25.86	1488	24.3	69.5	880	D31029
X 51	62.3	111.1	50.8	28.6	76.2	15.9	3	1469	7.43	25.86	1982	32.3	92.6	1100	D31030
Z 25	75	130.2	25.4	34.9	88.9	19	3	1047	4.46	30.68	1190	23	60.7	860	D31031
Z 38	75	130.2	38.1	34.9	88.9	19	3	1570	6.69	30.68	1785	34.5	90.9	1400	D31032
Z 51	75	130.2	50.8	34.9	88.9	19	3	2098	8.95	30.68	2388	46.2	122	1800	D31033
Z 70	75	130.2	69.8	34.9	88.9	19	3	2876	12.27	30.68	3273	63.3	167	2400	D31034
AD 32	97.2	169.9	31.7	44.4	114.3	25.4	3	2292	7.44	40.23	1987	50.4	119	2400	D31035
AD 51	97.2	169.9	50.8	44.4	114.3	25.4	3	3660	11.89	40.23	3172	80.5	189	3800	D31036

Core-based assemblies

SINGLE-PHASE CORES

→ Single-phase cores SM sheet metal type 30/100 in accordance with DIN 41309

Bobbins according to pages 61 to 65.

The electrical characteristics are given for $B = 1.7 \text{ T}$ and $F = 50 \text{ Hz}$.

The transmissible powers P_t are given as an indication and for a single core.

Type SM **	Mechanical characteristics							Physical characteristics				Electrical characteristics			(1 core)
	A max.	B max.	D 0 +0.8	G min.	F min.	E min.	R max.	mFe g	AFe cm ²	LFI cm	U2S mV/sp	PL W	S VA	Pt VA	Code
30a	14.3	28.6	6.5	21	7	3	1	9.1	0.18	6.6	6.8	0.02	0.13	0.5	D30603
b	14.3	28.6	10.5	21	7	3	1	14.7	0.29	6.6	10.9	0.03	0.21	0.7	D30604
42	21.8	43.6	14.5	31	9.5	5.2	1.5	54.1	0.72	9.8	27.2	0.11	0.7	4	D30605
55	28.4	56.3	20	38.5	11	7.7	1.5	138	1.46	12.4	55.1	0.28	1.79	13	D30606
65	33.2	65.6	26.2	45	13	9	1.5	250	2.24	14.6	84.5	0.5	3.25	32	D30607
74	37.7	74.6	31.5	51	14.5	10.5	1.5	396	3.14	16.5	118.5	0.79	4.4	55	D30608
85a	43.2	85.6	31.5	56	14	13.4	2	561	4.01	18.3	151.3	1.12	6.17	90	D30609
b	43.2	85.6	44.5	56	14	13.4	2	792	5.66	18.3	213.6	1.58	8.71	135	D30610
102a	51.9	103	34.5	68	17.5	15.9	2	885	5.21	22.2	196.6	1.77	9.74	155	D30601
b	51.9	103	51.5	68	17.5	15.9	2	1321	7.78	22.2	293.6	2.64	14.5	260	D30602

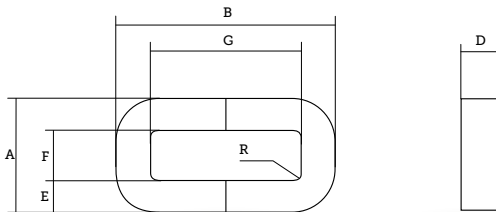

ADDITIONAL PRODUCTS

61 · 65

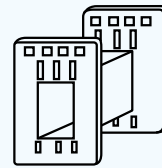

25 · 27

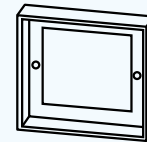

82 · 85

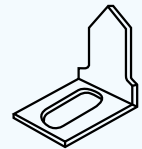

→ Single-phase cores SE sheet metal type 30/100 in accordance with DIN 41309

Type SE **	Mechanical characteristics							Physical characteristics				Electrical characteristics			(1 core)
	A max.	B max.	D 0 +0.8	G min.	F min.	E min.	R max.	mFe g	AFe cm ²	LFI cm	U2S mV/sp	PL W	S VA	Pt VA	Code
60	30.5	52.2	19.7	32	10.5	9.1	1.5	148	1.7	11.4	64.2	0.3	1.95	20	D30717
66	33.5	57.2	21.7	35	11.5	10.1	1.5	199	2.08	12.5	78.5	0.4	2.6	28	D30718
78	39.5	68.2	26.1	42	13.5	12.1	2	342	3	14.9	113.2	0.68	4.15	50	D30719
84a	46.2	73.4	28	45	14.5	13.1	2	426	3.48	16	131.3	0.85	5.05	65	D30720
b	46.2	73.4	42	45	14.5	13.1	2	640	5.23	16	197.4	1.28	70.6	120	D30721
92a	46.2	77.6	23	54	23	10.6	2	332	2.32	18.7	87.5	0.66	3.8	48	D30722
b	46.2	77.6	32	54	23	10.6	2	461	3.22	18.7	121.5	0.92	5.1	75	D30723
106a	53.2	88.6	32	59	24	13.6	2	660	4.13	20.9	155.8	1.32	7.25	125	D30701
b	53.2	88.6	45	59	24	13.6	2	930	5.81	20.9	219.2	1.86	10.3	175	D30702
130a	65.3	108.8	36	73	30	16.5	2	1117	5.64	25.9	214.7	2.24	12.45	220	D30703
b	65.3	108.8	46	73	30	16.5	2	1429	7.21	25.9	272	2.86	15.75	300	D30704
150a	75.2	123.8	40	83	35	18.9	2	1631	7.18	29.7	271	3.26	17.95	350	D30705
b	75.2	123.8	50	83	35	18.9	2	2040	8.98	29.7	339	4.08	22.45	500	D30706
c	75.2	123.8	60	83	35	18.9	2	2454	10.8	29.7	407	4.9	26.95	560	D30707
170a	85	145.8	54.5	100	40	21.1	3	2920	11	34.7	412	5.84	32.15	650	D30708
b	85	145.8	64.5	100	40	21.1	3	3424	12.9	34.7	188	6.84	37.6	820	D30709
c	85	145.8	74.5	100	40	21.1	3	3955	14.9	34.7	563	7.92	43.55	1000	D30710
195a	98.2	186.8	55.5	130	42.5	26.2	3	4529	13.8	42.9	521	9.06	49.85	1100	D30711
b	98.2	186.8	68.5	130	42.5	26.2	3	5579	17	42.9	644	11.16	62.4	1300	D30712
c	98.2	186.8	83.5	130	42.5	26.2	3	6826	20.8	42.9	785	13.66	75.5	1500	D30713
231a	116.1	216	61.5	149	50.5	30.8	3	6871	18	49.9	680	13.74	76	1850	D30714
b	116.1	216	77.5	149	50.5	30.8	3	8665	22.7	49.9	856	17.34	95.4	1950	D30715
c	116.1	216	96.5	149	50.5	30.8	3	10765	28.2	49.9	1065	21.54	118.5	3050	D30716

→ Single-phase cores SU type (30/100) in accordance with DIN 41309

Bobbins pages 61 to 65 (UI type).

The electrical characteristics are given for $B = 1.7 \text{ T}$ and $F = 50 \text{ Hz}$.

The transmissible powers P_t are given as an indication and for a single core.

Type SU **	Mechanical characteristics							Physical characteristics				Electrical characteristics			(1 core)
	A max.	B max.	D 0+0.8	G min.	F min.	E min.	R max.	mFe g	AFe cm ²	LFI cm	U2S mV/sp	PL W	S VA	Pt VA	Code
15 a	15	28.7	5	18.5	5	4.4	1.5	10	0.22	6.1	7.9	0.02	0.14	0.5	D30350
b	15	28.7	8	18.5	5	4.4	1.5	15	0.33	6.1	12.5	0.03	0.21	0.7	D30351
24 a	24	42.7	8	26.5	8	7.3	1.5	40	0.56	9.2	21.2	0.08	0.56	3	D30355
b	24	42.7	13	26.5	8	7.3	1.5	64	0.95	9.2	34	0.14	0.84	5	D30356
30 a	30	52.7	9.5	32.5	10	9.1	1.5	72	0.82	11.4	31	0.15	0.94	7	D30325
b	30	52.7	15.5	32.5	10	9.1	1.5	117	1.34	11.4	50.6	0.24	1.52	10	D30326
39 a	39.1	67.9	12.5	41.5	13	12.1	1.5	163	1.44	14.8	54.3	0.33	2.12	19	D30327
b	39.1	67.9	19.5	41.5	13	12.1	1.5	254	2.24	14.8	84.5	0.51	3.3	33	D30328
48 a	48	82.9	15.5	50.5	16	14.9	1.5	303	2.19	18.1	82.6	0.61	3.95	40	D30329
b	48	82.9	24.5	50.5	16	14.9	1.5	480	3.47	18.1	131	0.96	5.75	65	D30330
60 a	60.1	103.6	19.5	63	20	18.9	2	605	3.5	22.6	132.1	1.31	7.25	100	D30331
b	60.1	103.6	29.5	63	20	18.9	2	916	5.3	22.6	200	1.83	10.08	150	D30332
75 a	75	128.6	25	78	25	23.7	2	1215	5.63	28.2	212.5	2.43	13.4	240	D30333
b	75	128.6	40	78	25	23.7	2	1944	9.01	28.2	340	3.89	21.4	400	D30334
90 a	90	155.8	29.5	95	30	28.5	3	2078	7.99	34	301.5	4.16	22.9	440	D30335
b	90	155.8	49.5	95	30	28.5	3	3485	13.4	34	506	6.98	38.4	800	D30336
102 a	102.4	175.4	34	105	34	32.5	3	3084	10.5	38.4	396	6.17	42.4	900	D30337
b	102.4	175.4	55	105	34	32.5	3	4994	17	38.4	642	9.99	54.95	1200	D30338
114 a	114.4	195.6	37.5	118	38	36.3	3	4234	12.9	42.8	487	8.47	46.6	1050	D30339
b	114.4	195.6	61.5	118	38	36.3	3	6958	21.2	42.8	800	13.92	76.6	1840	D30340
132 a	132.1	225.4	43.5	136	44	42	3	6589	17.4	49.5	657	13.18	72.5	1800	D30341
b	132.1	225.4	69.5	136	44	42	3	10489	27.7	49.5	1046	20.98	116	3000	D30342
150 a	150.2	255.6	49.5	154	50	47.9	3	9673	22.5	56.2	850	19.35	107	2800	D30343
b	150.2	255.6	74.5	154	50	47.9	3	14575	33.9	56.2	1280	29.16	161	5000	D30344
168 a	168.3	286	55	172	56	53.7	3	13543	28.1	63	1060	27.09	149	4500	D30345
b	168.3	286	89	172	56	53.7	3	21881	45.4	63	1715	43.76	241	6000	D30346
180 a	181.3	307.2	60	184	60	57.9	3	17066	33	67.6	1245	34.14	188	5500	D30347
b	181.3	307.2	75	184	60	57.9	3	21358	41.3	67.6	1560	42.72	235	6500	D30348
c	181.3	307.2	90	184	60	57.9	3	25598	49.5	67.6	1870	51.2	282	7500	D30349
210 a	211.2	357.2	69.5	214	70	67.6	3	26851	44.6	78.7	1684	53.7	295	8500	D30352
b	211.2	357.2	99.5	214	70	67.6	3	38471	63.9	78.7	2413	76.9	423	12000	D30353
c	211.2	357.2	129.5	214	70	67.6	3	50091	83.2	78.7	3142	100.2	551	15000	D30354

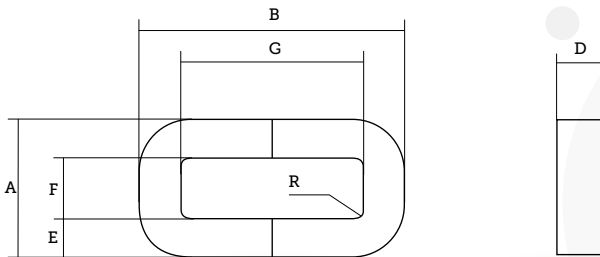

ADDITIONAL PRODUCTS

61 · 65

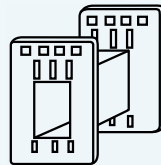

25 · 27

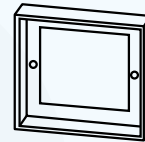

82 · 85

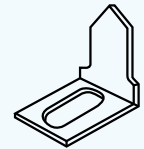

Core-based assemblies

THREE-PHASE CORES

→ Three-phase cores FA 30/FA 100 type in accordance with NFC 93 326

The electrical characteristics are given for $B = 1.5 \text{ T}$ and $F = 50 \text{ Hz}$ (FA30**).

The electrical characteristics are given for $B = 1.5 \text{ T}$ and $F = 400 \text{ Hz}$ (FA10**).

The transmissible powers P_t are given as an indication.

All of these three-phase cores can be run with other standard widths.

Type FA*	Mechanical characteristics							FA30** characteristics						FA10** characteristics							
								Physical characteristics			Electrical characteristics			Code	Physical characteristics			Electrical characteristics			Code
	A	B	D	F	G	E	R	mFe	AFe	U2S	PL	S	Pt		mFe	AFe	U2S	PL	S	Pt	
max.	max.	min.	min.	min.	min.	max.	g	cm ²	mV/sp	W	VA	VA	g	cm ²	mV/sp	W	VA	VA			
EA 8	53	45	7.9	13	25	8	1.6	0.078	0.6	20	0.163	1.19	6	D30102	0.075	0.58	134	1.5	6.45	45	D31102
EA 13	53	45	12.7	13	25	8	1.6	0.125	0.96	32	0.263	1.9	10	D30103	0.121	0.93	215	2.42	10.4	75	D31103
EA 16	53	45	15.9	13	25	8	1.6	0.156	1.21	40.3	0.328	2.38	15	D30104	0.151	1.17	271	3.02	13	110	D31104
EB 10	65	56	9.5	16	32	10	1.6	0.146	0.9	30	0.307	1.94	17	D30105	0.141	0.87	202	2.84	10.6	130	D31105
EB 13	65	56	12.7	16	32	10	1.6	0.196	1.21	40.3	0.412	2.61	20	D30106	0.19	1.17	271	3.8	14.2	150	D31106
EB 16	65	56	15.9	16	32	10	1.6	0.245	1.51	50.3	0.515	3.26	25	D30107	0.237	1.46	338	4.75	17.7	190	D31107
EB 19	65	56	19	16	32	10	1.6	0.293	1.8	60	0.615	3.9	30	D30108	0.284	1.74	403	5.68	21.2	225	D31108
EB 22	65	56	22.2	16	32	10	1.6	0.342	2.11	70.3	0.72	4.55	35	D30109	0.331	2.04	472	6.64	24.8	260	D31109
EC 13	79.5	67.5	12.7	19	38.1	12.7	1.6	0.3	1.53	51	0.63	3.6	40	D30110	0.291	1.48	343	5.81	19.4	290	D31110
EC 16	79.5	67.5	15.9	19	38.1	12.7	1.6	0.376	1.92	64	0.79	4.51	45	D30111	0.364	1.86	430	7.28	24.3	330	D31111
EC 19	79.5	67.5	19	19	38.1	12.7	1.6	0.45	2.29	76.3	0.945	5.4	55	D30112	0.436	2.22	513	8.72	29.1	410	D31112
EC 25	79.5	67.5	25.4	19	38.1	12.7	1.6	0.6	3.06	104	1.26	7.2	75	D30113	0.582	2.96	685	11.7	39	560	D31113
ED 25	92	79.6	25.4	20.6	44.4	15.6	1.6	0.85	3.77	125	1.79	9.5	100	D30115	0.824	3.65	844	16.5	51.2	760	D31115
EF 29	95.2	86.2	28.6	22.2	50.8	15.6	1.6	1.04	4.24	141	2.19	11.1	125	D30116	1.01	4.11	950	20.2	60.1	950	D31116
EH 32	111.1	99	31.7	25.4	57.2	18.8	3.2	1.59	5.67	189	3.33	16.1	200	D30117	1.55	5.49	1270	30.8	86.2	1500	D31117
EK 32	127	111.8	31.7	28.6	63.5	22	3.2	2.1	6.65	221	4.4	20.1	300	D30118	2.04	6.45	1490	40.6	108	2100	D31118
EM 32	148.4	130.8	31.7	34.9	76.2	25.1	3.2	2.86	7.6	253	6	25.5	450	D30119	2.78	7.37	1700	55.4	137	3150	D31119
EP 32	174.2	156.6	31.7	38.1	88.9	31.5	3.2	4.17	9.5	316	8.75	35.3	680	D30120	4.05	9.21	2125	80.7	189	4700	D31120
ER 38	206	175.9	38.1	44.4	95.3	37.8	3.2	6.8	13.7	456	14.3	55.4	1000	D30121	6.6	13.28	3065	132	297	6800	D31121
ET 41	222.2	195.3	41.3	47.6	108	41	3.2	8.81	16.1	536	18.5	69.6	1450	D30122	8.6	15.61	3600	171	367	10000	D31122
EV 48	254.7	221.5	47.6	54	120.7	47.4	3.2	13.3	21.4	713	28	102	2800	D30123	13.9	20.75	4790	258	546	16000	D31123
EX 54	286.8	241.3	54	60.3	127	53.7	3.2	18.8	27.6	918	39.4	141	3500	D30124	18.3	26.77	6180	364	755	22000	D31124
EZ 60	326.1	268.2	60.3	69.9	140	60.1	3.2	26.4	34.4	1146	55.4	192	4800	D30125	25.6	33.34	7700	511	1030	29000	D31125

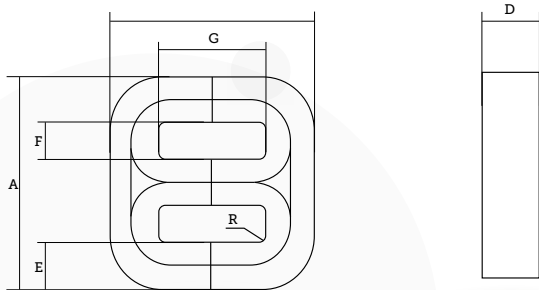

ADDITIONAL PRODUCTS

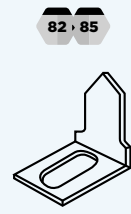

→ Three-phase cores s3U type type (30/100) in accordance with DIN

The electrical characteristics are given for B = 1.7 T and F = 50 hz.
 The transmissible powers Pt are given as an indication.

Type DIN S3U**	Type IEC 3U**	Mechanical characteristics									Physical characteristics			Electrical characteristics		Code
		A max.	B max. mm	E mm	Tol.	G mm	D mm	Tol.	F max.	R max. mm	AFe min. cm ²	mFe kg	U2S mV/sp	PL W	S VA	
30a	1.1	53.7	50.9	9.9	-0.8	32.5	10.1	-0.6	10	1.5	0.82	0.115	0.027	0.24	1.67	D30800
30b	1.2	53.7	50.9	9.9	-0.8	32.5	16.1	-0.6	10	1.5	1.34	0.188	0.045	0.40	2.73	D30801
39a	2.1	68.9	66	12.9	-0.8	41.5	13.4	-0.9	13	1.5	1.43	0.261	0.048	0.55	3.25	D30802
39b	2.2	68.9	66	12.9	-0.8	41.5	20.4	-0.9	13	1.5	2.24	0.407	0.075	0.86	5.07	D30803
48a	3.1	83.9	80.8	15.8	-0.9	50.5	16.6	-1	16	1.5	2.2	0.491	0.073	1.3	5.50	D30804
48b	3.2	83.9	80.8	15.8	-0.9	50.5	25.6	-1	16	1.5	3.49	0.776	0.116	1.63	8.69	D30805
60a	4.1	104.6	100.9	19.8	-0.9	63	20.6	-1.1	20	2	3.51	0.945	0.117	1.98	9.53	D30806
60b	4.2	104.6	100.9	19.8	-0.9	63	30.6	-1.1	20	2	5.3	1.47	0.117	3.9	14.8	D30807
75a	5.1	129.7	125.7	24.7	-1	78	26.1	-1.1	25	2	5.63	1.82	0.188	3.82	16.8	D30808
75b	5.2	129.7	125.7	24.7	-1	78	41.1	-1.1	25	2	9.01	2.93	0.300	6.15	27.0	D30809
90a	6.1	156.8	150.6	29.6	-1.1	95	30.9	-1.4	30	3	7.99	3.33	0.267	6.99	28.7	D30810
90b	6.2	156.8	150.6	29.6	-1.1	95	50.9	-1.4	30	3	13.4	5.59	0.447	11.7	48.1	D30811
102a	7.1	176.4	171.1	33.7	-1.2	106	35.4	-1.4	34	3	10.5	4.94	0.350	10.4	40.8	D30812
102b	7.2	176.4	171.1	33.7	-1.2	106	56.4	-1.4	34	3	17	8	0.566	16.8	66.1	D30813
114a	8.1	196.2	191	37.6	-1.3	118	39.2	-1.7	38	3	12.9	6.79	0.430	14.3	54.3	D30814
114b	8.2	196.2	191	37.6	-1.3	118	63.2	-1.7	38	3	21.2	11.14	0.703	23.4	89.1	D30815
132a	9.1	226.4	220.5	43.4	-1.4	136	45.2	-1.7	44	3	17.4	10.54	0.580	22.1	81.0	D30816
132b	9.2	226.4	220.5	43.4	-1.4	136	71.2	-1.7	44	3	27.7	16.84	0.923	35.4	129.0	D30817
150a	10.1	255.6	249.6	49.4	-1.5	154	51.2	-1.7	50	3	22.5	15.53	0.750	32.6	116.0	D30818
150b	10.2	255.6	249.6	49.4	-1.5	154	76.2	-1.7	50	3	33.9	23.38	1.130	49.1	174.0	D30819
168a	11.1	286	279.6	55.3	-1.6	172	57	-2	56	3	28.1	21.68	0.937	45.6	157.0	D30820
168b	11.2	286	279.6	55.3	-1.6	172	91	-2	56	3	45.4	35.07	1.514	73.5	255.0	D30821
180a	12.1	307.2	301	59.7	-1.8	184	62	-2	60	3	33	27.38	1.10	57.5	196.0	D30822
180b	12.2	307.2	301	59.7	-1.8	184	77	-2	60	3	41.3	34.23	1.38	71.8	245.0	D30823
180c	12.3	307.2	301	59.7	-1.8	184	92	-2	60	3	49.5	41.07	1.65	86.1	294.0	D30824
210a	13.1	357.2	350.8	69.6	-2	214	71.7	-2.2	70	3	44.6	43.12	1.49	90.5	299.0	D30825
210b	13.2	357.2	350.8	69.6	-2	214	101.7	-2.2	70	3	63.9	61.74	2.13	130	428.0	D30826
210c	13.3	357.2	350.8	69.6	-2	214	131.7	-2.2	70	3	83.2	80.35	2.77	169	557.0	D30827
240a	14.1	406.2	400.8	79.6	-2	243	81.7	-2.2	80	3	58.6	64.6	1.95	135	438.0	D30828
240b	14.2	406.2	400.8	79.6	-2	243	108.7	-2.2	80	3	78.5	86.5	2.615	182	587.0	D30829
240c	14.3	406.2	400.8	79.6	-2	243	138.7	-2.2	80	3	100.6	111	3.35	233	753.0	D30830

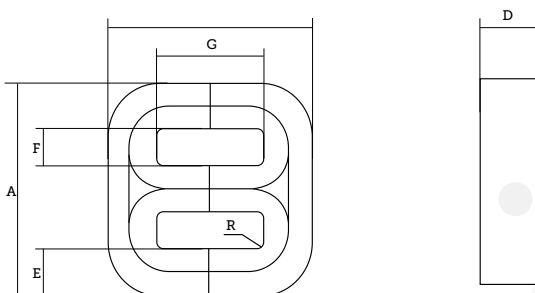

ADDITIONAL PRODUCTS

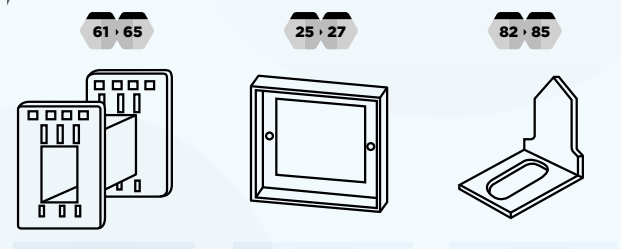

Core-based assemblies

BOBBINS AND TUBES FOR C CORES

→ Polyamide bobbins

Polyamide bobbins. Pins according to pages 82 to 85 Type A. Tolerance 3/10

Ref.	Code	Fig.	Bobbins for 1 core							For core	Bobbins for 2 cores							Code	Ref.		
			b1	b2	h2	k	l1	n1	l2		l3	b1	h1	b2	l1	l2	l3			h2	k
110	A01112	1	5.4	5.4	14	10.9	12.9			5X5						15.4	5	1.5			
701	A04101	1	8	18.7	27.8	6.5	12.3	1	13.4	D6	15.7	7.9	26.2	11.4	13.4	27.5	6.6	0.9	A04201	2701	
702	A04103	1	9.8	23.5	32	7.7	14.2	1.2	16.6	F8	18.8	9.4	32.6	14	16.6	31.9	7.7	1.2	A04203	2702	
703	A04105	1	11.1	28.3	36.1	9	18.9	1.2	21.3	H10	22.2	11.1	39.1	18.9	20.7	36	8.9	1.2	A04205	2703	
704	A04107	1	11.1	31.5	39	10.5	25.3	1.2	27.7	J10	22.2	11	42.4	24.6	27.7	39	10.4	1.2	A04207	2704	
705	A04109	2	9.5	33.7	49.2	14.5	34	1.2	36.4	Q13	19.4	14.2	43.3	33	36.2	42	49.4	15.2	1.6	A04209	2708
706	A04111	2	9.5	33.9	55.1	14.9	34	1.2	36.4	Q19	19.2	21.3	43.7	33.2	36.2	42	56.4	15	1.5	A04211	2709
		2								Q19	19.2	21.3	43.7	33.2	36.2	42	56.4	15	1.5	A04212	2709JI
712	A04113	2	9.8		61.6	15	33.6	1.2	36	Q25	19.2	26.7	43.3	33	36	42	61.6	15	1.5	A04213	2713
		2								Q25	19.2	26.7	43.3	33	36	42	61.6	15	1.5	A04214	2713JI
707	A04115	2	9.6	33.9	74	14.9	34	1.2	36.4	Q38	19.2	39.6	43.2	33	36	41.9	74	15.1	1.5	A04215	2710
738	A04117	3	11.7	41.7	55.6	18	46.4	1.4	49.2	T13	22.6	14.6	52.4	46	49.2	55	55.5	17.8	1.5	A04217	2739
740	A04119	3	11.7	41.5	61.4	18.1	46.3	1.4	49.1	T19	23.3	20.7	53.2	46	49.1	55	61.6	18	1.5	A04219	2741
737	A04121	3	12.3	42.3	67.6	17.8	46	1.6	49.2	T25	23	26.6	53.1	46	49	55	67.5	17.8	1.6	A04221	2695
742	A04123	3	11.7	41.8	74.5	17.9	46	1.5	49	T32	23.1	33.7	53	46	49	55	74.5	17.9	1.5	A04223	2696
743	A04125	4	11.9	47.9	67	21	51.1	1.6	54.3	U19	23	20.8	59.8	51	54	59.6	66.7	21.2	1.5	A04225	2744
745	A04127	4	11.9	48	73.1	21	51.3	1.4	54.4	U25	23	26.7	58.8	51	54	59.6	72.8	21.2	1.5	A04227	2746
747	A04129	4	11.8	48.1	80	21.4	51.1	1.6	54.3	U32	23.2	33.7	59.2	51	54	59.6	79.6	20.8	1.5	A04229	2697
715	A04131	4	11.9	48	86	21.1	51.5	1.4	54.3	U38	23.3	40	59	51	54	59.6	86.2	20.9	1.5	A04231	2714
748	A04133	5	15	59.5	78.7	25	56.6	1.8	60.2	V22	29.4	23.9	71.8	56.2	60.2	66	78.4	25	2	A04233	2698
716	A04135	5	15.1	59.3	85.5	25	56.4	1.8	60	V29	29.3	31.2	71.8	56.3	60.3	66	85.2	24.8	2	A04235	2717
749	A04137	5	15.1	59.2	94.8	24.9	56.5	1.9	60.3	V38	29.5	40.2	71.9	56.1	60.1	66	95	25	2	A04237	2699
718	A04139	5	15.1	59.6	107.8	25	56.3	1.9	60.3	V51	29.5	53.1	71.9	56.3	60.3	66	108	24.9	2	A04239	2719

BOBBINS FOR 1 CORE

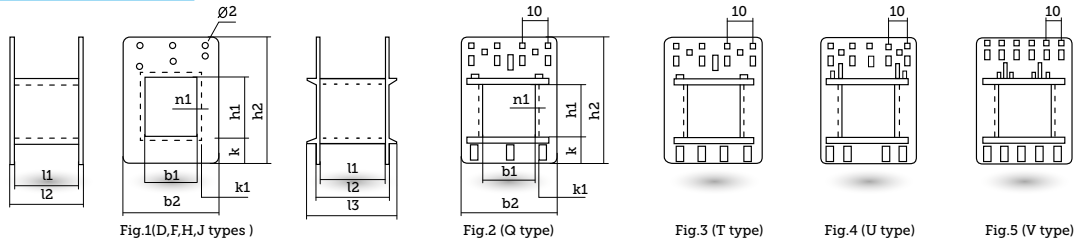

BOBBINS FOR 2 CORES

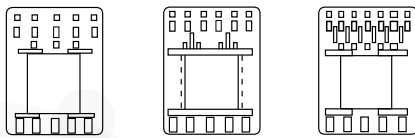

ADDITIONAL PRODUCTS

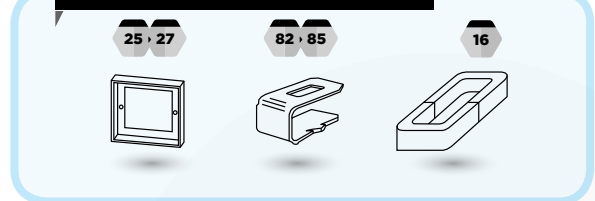

→ Bobbins C type pin outputs for CI

Square pins 0.5mm height 0.8mm.

Code	For core	Designation	Ref.
B64101	SG27/6/1ST	Wz6340/1ST UL	SD06
B64105	SG33/7/1ST	Wz6374/1ST UL	SF08

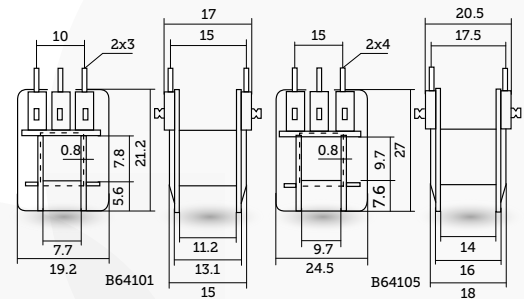

→ Bobbins for plugged pin cores

Pins according to Weisser Catalogue type B - C - D.

Ref.	Code	b1	h1	b3	b4	f1	h2	l1	l2	l3	l5	s3	x1	x2	x
703	A04106	11.4	11.1	28.3	28.3	9	36.1	18.9	21.3	21.3	32.7	1.2	20	28	2x5
SQ13	B64106	18.8	11.1	41.3	45.5	11.3	40.5	33.5	36.5	44.3	45	1.3	4x5	40	2x7
SQ19	B64108	18.8	20.4	41.3	45.5	11.3	46.8	33.5	36.5	44.3	45	1.3	4x5	40	2x7
SQ25	B64110	18.8	26.8	41.3	45.5	11.3	55.2	33.5	36.5	44.3	45	1.3	4x5	40	2x7
SQ38	B64112	18.8	39.5	41.3	45.5	11.3	67.9	33.5	36.5	44.3	45	1.3	4x5	40	2x7
SU19	B64122	22.2	20.5	57.2	57	18	60	50.6	54	62	63	1.5	5x5	57.5	2x8
SU25	B64124	22.2	26.8	57.2	57	18.1	66.8	50.6	54	62	63	1.5	5x5	57.5	2x8
SU32	B64126	22.2	33.4	57.2	57	20.1	75	50.6	54	62	63	1.5	5x5	57.5	2x8
SU38	B64128	22.2	39.3	57.2	57	20.1	81.2	50.6	54	62	63	1.5	5x5	57.5	2x8

→ Presspahn bobbins for C cores A type

Wire passage holes: Ø2. Terminals according to pages 82 to 85.

Ref.	Code	Bobbins for 1 core					For core	Bobbins for 2 cores								Code	Ref.
		b1	b2	h2	l1	l2		b1	h1	b2	h2	k	l1	n1	l2		
750	A10203P	18	74	91.5	67	72	X 19	35.5	20.5	90	90	33	67	2.5	72	A10251P	2751
720	A10205P	17.5	73	100	67	72	X 29	35	31	91	102	33	67	2.5	72	A10253P	2721
722	A10207P	17.5	72	112	67	72	X 38	35	40	90	112	33	67	2.5	72	A10255P	2711
723	A10209P	18	72.5	125	67	72	X 51	35	53	90	121	33	67	2.5	72	A10257P	2724
752	A10211P	21	89	111.5	81	86	Z 25	41.5	26.5	109.5	111.5	40	81	2.5	86	A10259P	2753
754	A10213P	21	89	124.5	81	86	Z 38	41.5	39.5	109.5	124.5	40	81	2.5	86	A10261P	2755
725	A10215P	21	88	138	81	86	Z 51	42	53	109	140	40	81	2.5	86	A10263P	2726
727	A10217P	21	89	157	81	86	Z 70	42	72	110	155	40	81	2.5	86	A10265P	2728
729	A10219P	27.5	113	138	104	110	AD 32										
731	A10221P	27.5	113.5	158	104	110	AD 51	54	53	140	160	50	104	3	110	A10269P	2732
							AJ 32	68.5	34	178.5	165	62	135	3.5	142	A10271P	2761
							AJ 51	68.5	53	178.5	184	62	135	3.5	142	A10273P	2762
							AP 32	84.5	34	222.5	193	76	170	3.5	177	A10275P	2763

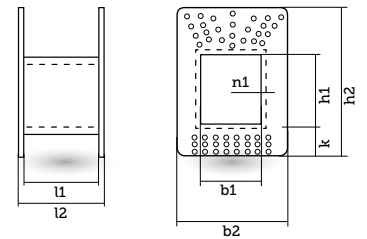

→ Tubes for cut cores C type

For fiberglass tubes = S / For presspahn tubes = P

A - D - C dimensions identical for 1 or 2 cores.

Tubes for 1 core								Tubes for 2 cores							
Ref.		Code		A	B	C	D*	For core	B	Code		Ref.			
P	S	P	S							P	S	P	S		
54 P	54S	B41054P	B41054P	7.3	7.3	13.3	1	D 6	14	B41258P	B42258P	258 P	258 S		
55 P	55S	B41055P	B42055P	9.3	9.3	16.3	1	F 8	18	B41259P	B42259P	259 P	259 S		
56 P	56S	B41056P	B41056P	11.3	11.3	21.3	1	H 10	22	B41260P	B42260P	260 P	260 S		
57 P	57S	B41057P	B41057P	11.3	11.3	28.3	1	J 10	22	B41261P	B42261P	261 P	261 S		
28 P	28S	B41028P	B42028P	14.3	9.3	37	1.5	Q 13	19	B41201P	B42201P	210 P	210 S		
29 P	29S	B41029P	B42029P	20.3	9.3	37	1.5	Q 19	19	B41202P	B42202P	202 P	202 S		
30 P	30S	B41030P	B42030P	26.3	9.3	37	1.5	Q 25	19	B41203P	B42203P	203 P	203 S		
31 P	31S	B41031P	B42031P	39.3	9.3	37	1.5	Q 38	19	B41204P	B42204P	204 P	204 S		
32 P	32S	B41032P	B42033P	14.3	11.3	49	1.5	T 13	22.5	B41205P	B42205P	205 P	205 S		
33 P	33S	B41033P	B42033P	20.3	11.3	49	1.5	T 19	22.5	B41206P	B42206P	206 P	206 S		
34 P	34S	B41034P	B42034P	26.3	11.3	49	1.5	T 25	22.5	B41207P	B42207P	207 P	207 S		
35 P	35S	B41035P	B42035P	33.3	11.3	49	1.5	T 32	22.5	B41208P	B42208P	208 P	208 S		
36 P	36S	B41036P	B42036P	20.3	11.3	54	1.5	U 19	22.5	B41209P	B42209P	209 P	209 S		
37 P	37S	B41037P	B42037P	26.3	11.3	54	1.5	U 25	22.5	B41210P	B42210P	210 P	210 S		
38 P	38S	B41038P	B42038P	33.3	11.3	54	1.5	U 32	22.5	B41211P	B42211P	211 P	211 S		
39 P	39S	B41039P	B42039P	39.3	11.3	54	1.5	U 38	22.5	B41212P	B42212P	212 P	212 S		
40 P	40S	B41040P	B42040P	23.3	14.3	60	1.5	V 22	28.5	B41213P	B42213P	213 P	213 S		
41 P	41S	B41041P	B42041P	30.3	14.3	60	1.5	V 29	28.5	B41214P	B42214P	214 P	214 S		
42 P	42S	B41042P	B42042P	39.3	14.3	60	1.5	V 38	28.5	B41215P	B42215P	215 P	215 S		
43 P	43S	B41043P	B42043P	52.3	14.3	60	1.5	V 51	28.5	B41216P	B42216P	216 P	216 S		
44 P	44S	B41044P	B42044P	20.3	17.3	73	2	X 19	35	B41217P	B42217P	217 P	217 S		
45 P	45S	B41045P	B42045P	30.3	17.3	73	2	X 29	35	B41218P	B42218P	218 P	218 S		
46 P	46S	B41046P	B42046P	39.3	17.3	73	2	X 38	35	B41219P	B42219P	219 P	219 S		
47 P	47S	B41047P	B42047P	52.3	17.3	73	2	X 51	35	B41220P	B42220P	220 P	220 S		
48 P	48S	B41048P	B42048P	26.3	20.3	85	2	Z 25	41	B41221P	B42221P	221 P	221 S		
49 P	49S	B41049P	B42049P	39.3	20.3	85	2	Z 38	41	B41222P	B42222P	222 P	222 S		
50 P	50S	B41050P	B42050P	52.3	20.3	85	2	Z 51	41	B41223P	B42223P	223 P	223 S		
51 P	51S	B41051P	B42051P	71.3	20.3	85	2	Z 70	41	B41224P	B42224P	224 P	224 S		
52 P	52S	B41052P	B42052P	33.3	27.5	111	2.5	AD 32	53.3	B41225P	B42225P	225 P	225 S		
53 P	53S	B41053P	B42053P	52.3	27.5	111	2.5	AD 51	53.3	B41226P	B42226P	226 P	226 S		
62 P	62S	B41062P	B42062P	33.3	34.5	141	2.5	AJ 32	68	B41266P	B42266P	266 P	266 S		
63 P	63S	B41063P	B42063P	52.3	34.5	141	2.5	AJ 51	68	B41267P	B42267P	267 P	267 S		
64 P	64S	B41064P	B42064P	33.3	42.5	176	2.5	AP 32	84	B41568P	B42568P	268 P	268 S		
65 P	65S	B41065P	B42065P	52.3	42.5	176	2.5	AP 51	84	B41269P	B42269P	269 P	269 S		

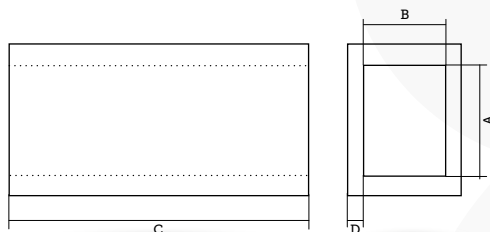

ADDITIONAL PRODUCTS

16

25 · 27

* (+/- 0.2)

Core-based assemblies

BOBBINS AND TUBES FOR THREE-PHASE CORES

→ Tubes for three-phase cores

For fiberglass tubes = S
For presspahn tubes = P

				Core	Code		Ref.	
A	B	C	D		P	S	P	S
9	9	24.5	1	EA 8	B43051P	B44051P	3051 P	3051 S
9	14	24.5	1	EA 13	B43052P	B44052P	3052 P	3052 S
9	17	24.5	1	EA 16	B43053P	B44053P	3053 P	3053 S
11	11	31.5	1	EB 10	B43054P	B44054P	3054 P	3054 S
11	14	31.5	1	EB 13	B43055P	B44055P	3055 P	3055 S
11	17	31.5	1	EB 16	B43056P	B44056P	3056 P	3056 S
11	20	34.5	1	EB 19	B43057P	B44057P	3057 P	3057 S
11	23	31.5	1	EB 22	B43058P	B44058P	3058 P	3058 S
14	14	37	1	EC 13	B43059P	B44059P	3059 P	3059 S
14	17	37	1	EC 16	B43060P	B44060P	3060 P	3060 S
14	20	37	1	EC 19	B43061P	B44061P	3061 P	3061 S
14	26	37	1	EC 25	B43062P	B44062P	3062 P	3062 S
23	14	42	1	ED 13	B43063P	B44063P	3063 P	3063 S
26.5	17.5	43	1.5	ED 25	B43064P	B44064P	3064 P	3064 S
30.5	17.5	50	1.5	EF 29	B43065P	B44065P	3065 P	3065 S
33.5	20.5	55	1.5	EH 32	B43066P	B44066P	3066 P	3066 S
33.5	23.5	61	1.5	EK 32	B43067P	B44067P	3067 P	3067 S
33.5	26.3	74	1.5	EM 32	B43068P	B44068P	3068 P	3068 S
33.5	33.5	87	1.5	EP 32	B43069P	B44069P	3069 P	3069 S
39.5	39.5	93	2	ER 38	B43070P	B44070P	3070 P	3070 S
42.5	42.5	106	2	ET 41	B43071P	B44071P	3071 P	3071 S
49.5	49.5	119	2.5	EV 48	B43072P	B44072P	3072 P	3072 S
55.5	55.5	125	2.5	EX 54	B43073P	B44073P	3073 P	3073 S
61.5	61.5	138	2.5	EZ 60	B43074P	B44074P	3074 P	3074 S

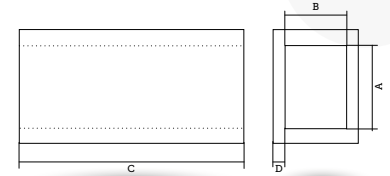

ADDITIONAL PRODUCTS

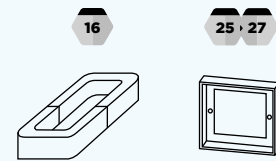

→ Bobbins for three-phase cores

For fiberglass tubes = S
For presspahn tubes = P

A	B	C	D	E	F	I	H	Core	Code	Ref.
11.5	11.5	20	30	9	9	1.5	28	EB 10	A10300P	3000
15	27	30	50	11.5	11.5	1.5	36	EC 25	A10301P	3001
18	26.5	36	55	14.5	14.5	1.5	42	ED 25	A10302P	3002
17.5	31	36	60	14.5	14.5	1.5	49	EF 29	A10303P	3003
20.5	33.5	43	65	16	16	1.5	51	EH 32	A10304P	3004
24	34	49	70	18	18	2	57	EK 32	A10305P	3005
26.5	34	58	80	23	23	2	70	EM 32	A10306P	3006
34	34	68.5	89	27.5	27.5	2.5	83	EP 32	A10307P	3007
40	40	80	103	31.5	31.5	2.5	89	ER 38	A10308P	3008
43	43	87	110	33.5	33.5	2.5	102	ET 41	A10309P	3009
50	50	99	128	39	39	3	115	EV 48	A10310P	3010
62	62	128	128	33	33	3	137	EZ 60	A10311P	3011

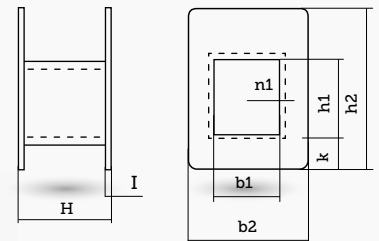

→ Full frames FEA type

Pins according to Weisser Catalogue type B - C - D.

Designation	Material	Ref.	Quantity
Locking screw	Steel	A	8
Cap screw	Steel	B	2
Flange	Steel	C	2
Spacer	Brass	D	4
Crimped nut	Steel	E	2
Crimped pillar	Brass	F	4
Spacer	Brass	G	8
Captive screw	Brass	H	4
Presspahn insulator	Paper	I	2
Lock washer	Steel	J	2
Captive screw	Brass	K	8

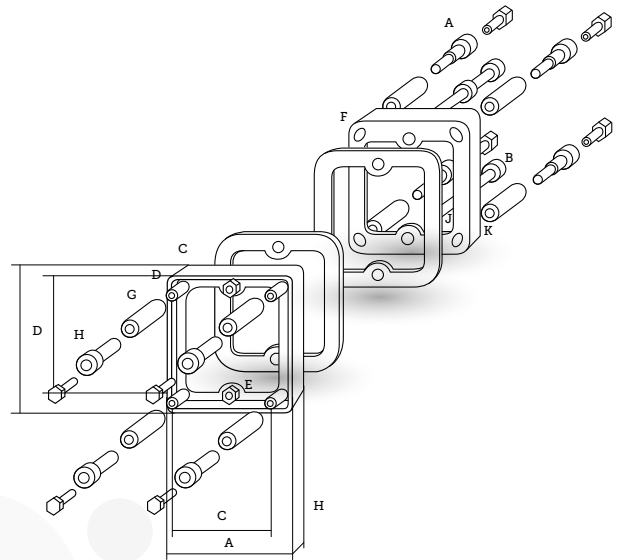

Assemblies for 2 cores
 Sold complete according to the details opposite.
 Complies with NF Standard C 93326

→ Full frames C type

R	S	Y	A	B	C	D	H	Code	Ref.
19	25.2	58	62.7	58	49.2	46	8	D35101V3	FEA 2 Q 13
19	25.1	64	62.7	58	49.2	46	8	D35102	FEA 2 Q 19
22.1	28.4	64.5	75.6	73.7	61.9	58.8	8	D35105	FEA 2 T 13
22.1	28.4	70.5	75.6	73.7	61.9	58.8	8	D35106	FEA 2 T 19
25	31.3	76	81.7	81.5	66.7	65.1	10.2	D35109	FEA 2 U 19
25	31.3	82	81.7	81.5	66.7	65.1	10.2	D35110	FEA 2 U 25

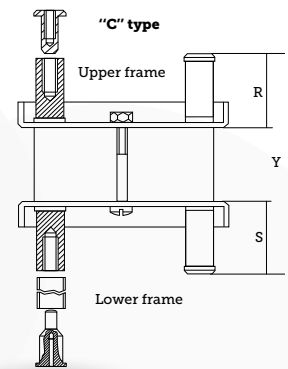

→ Full frames M type

R	S	Y	A	B	C	D	H	Code	Ref.
25.2	25.2	76	62.7	58	49.2	46	8	D35103V1	FEA 2Q 25
28.5	25.2	92.5	62.7	58	49.2	46	8	D35104	FEA 2Q 38
28.5	28.5	83	75.6	73.7	61.9	58.8	8	D35107	FEA 2T 25
31.5	28.5	93	75.6	73.7	61.9	58.8	8	D35108	FEA 2T 32
31.3	31.3	95.5	81.7	81.5	66.7	65.1	10.2	D35111	FEA 2U 32
34.5	31.3	104.5	81.7	81.5	66.7	65.1	10.2	D35112	FEA 2U 38
28.3	28.3	79.5	101.7	92	81	73	13	D35113	FEA 2V 22
28.3	28.3	86.5	101.7	92	81	73	13	D35114	FEA 2V 29
34.7	28.3	102	101.7	92	81	73	13	D35115	FEA 2V 38
37.8	28.3	118	101.7	92	81	73	13	D35116	FEA 2V 51
34.3	34.3	88.5	127	111.6	101.6	87.3	15.5	D35117	FEA 2X 19
34.3	34.3	98.5	127	111.6	101.6	87.3	15.5	D35118	FEA 2X 29
40.8	34.3	114	127	111.6	101.6	87.3	15.5	D35119	FEA 2X 38
43.9	34.3	130	127	111.6	101.6	87.3	15.5	D35120	FEA 2X 51
40.6	40.6	107	152	130.6	123.8	103.2	16	D35121	FEA 2Z 25
40.6	40.6	120	152	130.6	123.8	103.2	16	D35122	FEA 2Z 38
46.9	40.6	139.5	152	130.6	123.8	103.2	16	D35123	FEA 2Z 51
50.1	40.6	162	152	130.6	123.8	103.2	16	D35124	FEA 2Z 70
61.5	55.8	150	198.5	171.5	165	133.2	22	D35125	FEA 2AD 32
61.5	55.8	169	198.5	171.5	165	133.2	22	D35126	FEA 2AD 51
63	57.3	153	251	217	205	170	25	D35127	FEA 2AJ 32
63	57.3	172	251	217	205	170	25	D35128	FEA 2AJ 51

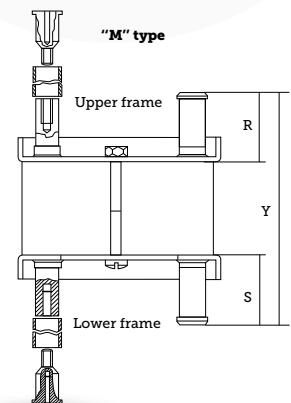

Core-based assemblies

ACCESSORIES FOR MOUNTING CUT CORES

→ FEB side fixing frames for cut C cores in accordance with F 93326

Zinc plated steel delivered in pairs with presspahn insulators and screws.

P	R	S	Code	Ref.
26	5.2	3.1	D35201V1	FEB 2Q
40	5.2	3.3	D35205	FEB 2T
44	6.2	4.3	D35209	FEB 2U
50	6.2	4.5	D35213	FEB 2V
50	7.6	5.5	D35217	FEB 2X
80	9.4	7	D35221	FEB 2Z
96	9.4	7.7	D35226	FEB 2AD
120	13	9	D35228	FEB 2AJ

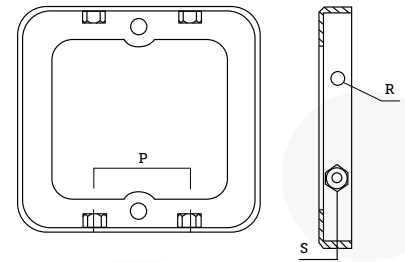

ADDITIONAL PRODUCTS

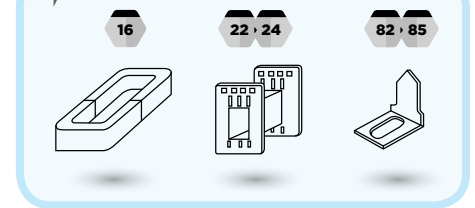

→ "Economy frame" set for C cores 89 series

Zinc plated steel delivered in pairs with presspahn insulators and screws.

A	B	C	D	E	F	G	H	J	K	L	M	N	O	P	R	Core	Code	Ref.
60	65	13	42	47	50	5.2	40	32	52	44	3.4	6	2.5	5	1.2	Q	D35260	89 Q
78	80	16	56	56	65	5.2	52	46	66	60	4.7	8	3	5	1.2	T	D35261	89 T
84	86	19	60	62	71	6.2	54	46	70	62	5.7	9	3	6	1.5	U	D35262	89 U
97	104	22	68	76	81	6.2	68	54	86	72	5.7	11	4	6	1.5	V	D35263	89 V
116	132	25	83	95	97	7.6	92	68	112	88	6.7	14	4	7	1.8	X	D35264	89 X
136	154	30	97	114	113	9.4	106	80	130	104	6.7	16	6	9	2	Z	D35265V1	89 Z

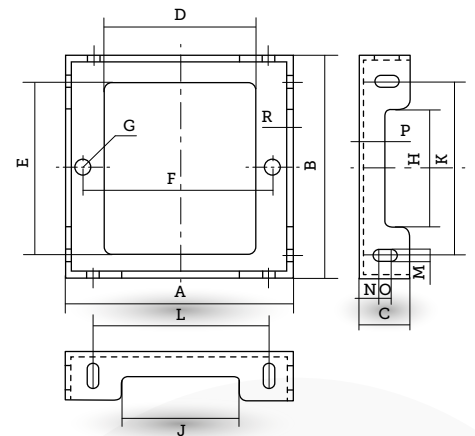

→ "FD" type shielding BOX

Tin plate sheet metal. The set includes 2 covers and a skirt.

A	B	C	Code	Ref.
74	69	60	D35301	FD2Q13
74	69	66	D35302	FD2Q19
74	69	79	D35303V1	FD2Q25
74	69	95	D35304	FD2Q38
86	84	65.5	D35305	FD2T13
86	84	71.5	D35306	FD2T19
86	84	84	D35307	FD2T25
86	84	94	D35308	FD2T32
98	93	79	D35309	FD2U19
98	93	86	D35310	FD2U25
98	93	98	D35311	FD2U32
98	93	108	D35312	FD2U38
115	105	84	D35313	FD2V22
115	105	91	D35314	FD2V29
115	105	106.5	D35315	FD2V38
115	105	122.5	D35316	FD2V51
140	125	102	D35318	FD2X29
140	125	117	D35319	FD2X38
140	125	133	D35320	FD2X51
167	148	124	D35322	FD2Z38
167	148	144	D35323	FD2Z51
167	148	167	D35324	FD2Z70

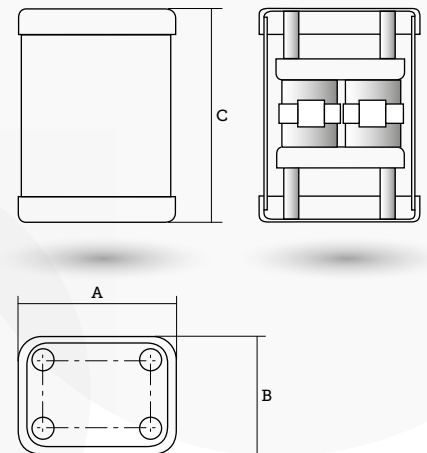

→ Dinex set for SM cores 410.SM series

Zinc plated steel delivered in pairs with presspahn insulators and screws.

A	B	C	D	E	F	G	H	I	J	K	L	R	Screw	Ref.	Code
51	50	34	2.8	3.6	32	43	26	7	7	12.5	5	1	M 2.5X22	410.SM.42	D35270
66	64	42	3.6	3.6	44	55	34	7	7	12.5	5	1	M 3X30	410.SM.55	D35272
75	73	50	3.6	4.8	50	64	38.5	8.5	9	15	7	1.2	M 3X35	410.SM.65	D35274
85	83	56	3.6	4.8	56	72.5	43.5	8.5	9	15	8	1.2	M 3X40	410.SM.74	D35276
95	93	62	4.8	4.8	64	82	48.5	8.5	9	15	8	1.5	M 4X40	410.SM.85A	D35278 ⁽¹⁾
113	111	74	4.8	5.8	84	98	57.5	10.5	11	18.5	10	1.5	M 4X45	410.SM.102A	D35280 ⁽²⁾

ADDITIONAL PRODUCTS

16

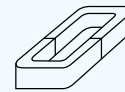

22, 24



82, 85

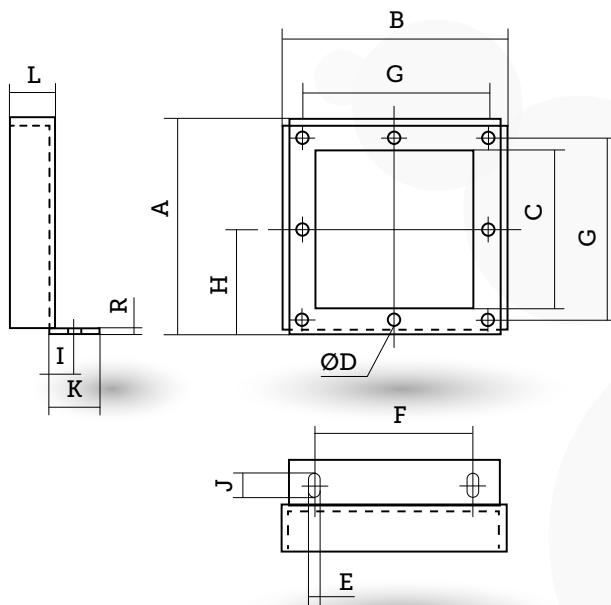

→ Distribution plates 230 series

A	B	C	D	R	Ø	e	Code 1 ⁽³⁾	Code 2 ⁽⁴⁾	Ref.
61	58	49	46	6	6.5	2	A37501	A37401	230 Q
76	72.5	62	58.5	7	6.5	2	A37502	A37402	230 T
82.5	81	66.5	65	8	8.5	2	A37503	A37403	230 U
101	93	81	73	10	8.5	2	A37504	A37404	230 V
125.5	111.5	101.5	87.5	12	10.5	2	A37505	A37405	230 X
152	131	125	103	14	12.5	2	A37506	A37406	230 Z
200	170	165	134	14	12.5	5		A37407	230 AD

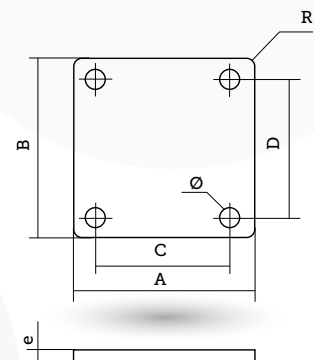

(1) D35279 comes with a 65 mm long screw

(2) D35282 comes with a 55 mm long screw

(3) Code 1: Bakelite fabric

(4) Code 2: Polyester

Core-based assemblies

ACCESSORIES FOR MOUNTING CUT CORES

→ Cut SU support in accordance with F 93326

Zinc plated sheet metal.
Delivered individually.

A	B	C	D	E	F	G	H Type A	H Type B	I	J	K	L	Code A	Code B	Ref.
13	8	4.8	47	6.5	9	10.5	26	33	37	25	13	1.5	**	D 36000	SU 39 a/b
10		4.5	62	5	7		28.8		53.8			1.5	D 36001*	**	SU 48 a/b
15		4.3	80.4	7.6	8		29.6		72.9			1.5	D 36003*	**	SU 60 a/b
19		7	98.6	9.2	12.8		41		85			1.5	D 36006*		SU 75 a/b

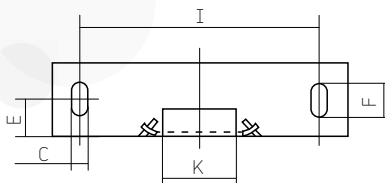
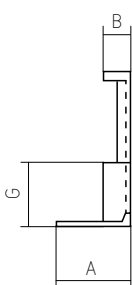
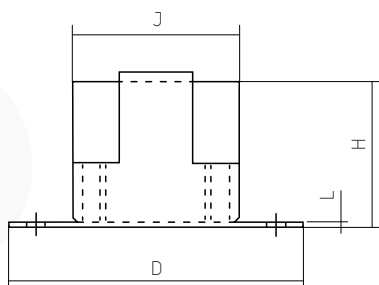

ADDITIONAL PRODUCTS

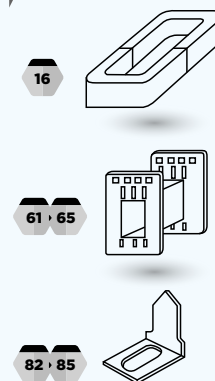

→ Clamping bands

Code	Ref.	Code	Ref.	Code	Ref.
A37601	05- D	A37633	411SU30	A37627	411SM102
A37602	05- F	A37634	411SU39	A37664	411SE60
A37603	05- H	A37635	411SU48	A37665	411SE66
A37604	05- J	A37636	411SU60	A37666	411SE78
A37605	05- Q	A37637	411SU75	A37667	411SE84
A37606	05- T	A37638	411SU90	A37668	411SE92
A37607	05- U	A37639	411SU102	A37669	411SE106
A37608	05- V	A37622	411SM42	A37670	411SE130
A37609	05- X	A37623	411SM55	A37671	411SE150
A37610	05- Z	A37624	411SM65	A37672	411SE170
A37611	05- AD	A37625	411SM74		
A37612	05- AJ	A37626	411SM85		
A37613	05- AP				

→ Special bands

CAPTIVE
SCREW CLAMP
TYPE CHC

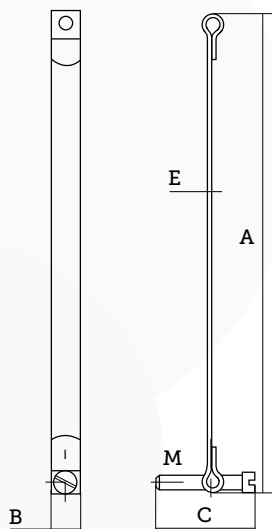
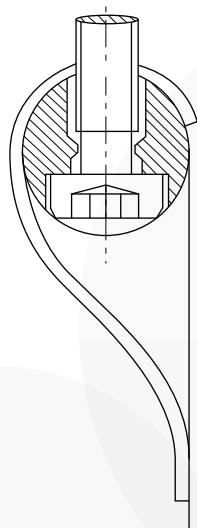

→ Banding strips

Material: Soft steel sheet annealing
Tin-plated on 2 sides
Also available in 4 side tin-plated
or amagnetic material versions
(consult us).

Tin-plated on
2 sides
A magnetic

Condit.	180ml/KG	90ml/kg	45ml/kg	
Type (AxB)	5 x 0.15	10 x 0.15	10 x 0.30	10x 0.20
▶ Code	D37201	D37202	D37203	D37220
▶ Code			D37205A	

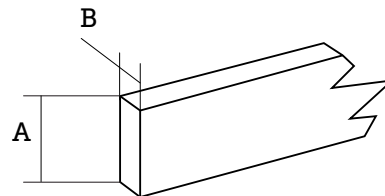

→ Tin plated staples

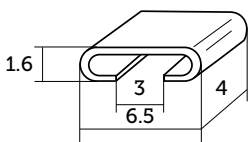

Code	Type	Ref.
D37221	A/2	1/1

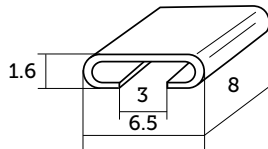

Code	Type	Ref.
D37211V1	A	A1- (161)

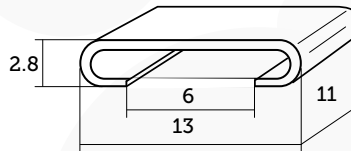

Code	Type	Ref.
D37212V1	B	2/2(160)

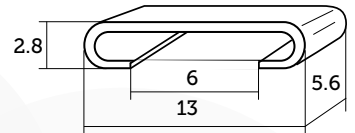

Code	Type	Ref.
D37213	B	2 (162)

→ Semi-automatic pneumatic tongs 164 type

A simple and effective work tool.
Strip tension adjustment by changing the
gauge pressure level.
The set comes complete and only requires
connecting to the air system.
Code: D35332
Pneumatic tong hire service
Code: Hire

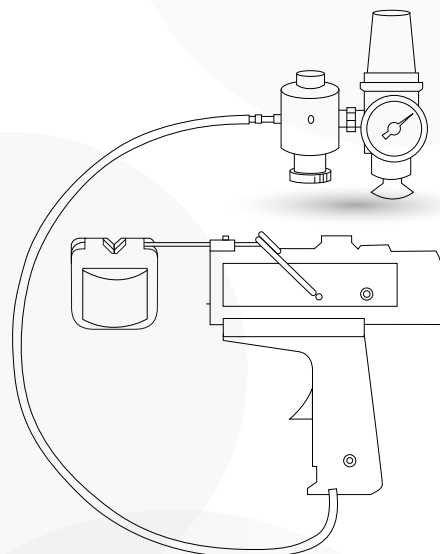
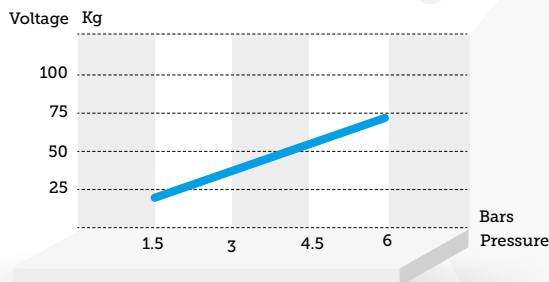

Core-based assemblies

BANDING FOR CUT CORES

→ Banding voltage table for cut cores

Core Type	Banding strips			Staples		Clamps	Voltage Kg
	Strip e x l	Length cm	Number	Staple Type	Number		
D 06	5x 0.15	12	1	A or A-/2	1		18
F 08		15					
H 10		18		A			
J 10		19		A			
Q 13	5x 0.15	20		A			
Q 19	10x 0.15			B or B-/2			35
Q 25							
Q 38	10x 0.30						70
T 13	10x 0.15	25					35
T 19							
T 25							
T 32	10x 0.30						70
U 19	10x 0.15	27		B or B-/2			35
U 25							
U 32	10x 0.30						70
U 38							
V 22	10x 0.30	32					
V 29							
V 38							
V 51			2		2		
X 19	10x 0.30	38	1	B or B/2	1		70
X 29							
X 38			2		2		
X 51							
Z 25	10x 0.30	44	1		1		
Z 38			2		2		
Z 51					2		
Z 70			3		3		
AD 32	10x 0.30	55	2		2		
AD 51			3		3		
AJ 32	10x 0.30	75	2		2		
AJ 51			3		3		
AP 32	10x 0.30	90	2		2		
AP 51			3		3		
AS 51	10x 0.30	112	4		4		
AS 70			6		6		
AS 100			8		8		
EA08	5x 0.15	25	1	A or A/2	1		18
EA13	10x 0.15			B or B/2			35
EA16	10x 0.15						
EB10	5x 0.15	29	1	A or A/2	1		18
EB13	10x 0.15			B or B/2			35
EB16				B or B-/2			
EB19	10x 0.30						70
EB22							
EC13	10x 0.15	35					35
EC16	10x 0.30						70
EC19							
EC25							
ED25	10x 0.30	40					
EF29		42					
EH32		48	2		2		
EK32		53					
EM32		61					
EP32		72					
ER38		82	3		3		
ET41		89					
EV48		102					
EV54		112	4		4		
EZ60		125					

INFORMATION RELATING TO BANDING

The core banding operation must be performed carefully and according to strict rules. This operation, insofar as it is carried out properly, ensures the best ratio of electrical value for completed sets.

1 Preparing the strip

Using the following table, define the recommended strip type and the staples to prepare the assembly according to the view opposite.

2 Preparing the cores

Prepare the cores in pairs while respecting the core pairing and the position of markers on the core (red dots for 30/100 sheet metals, white for 10/100 sheet metal).

3 Implementation

Checking the alignment of the cores before banding, pre-assembly in the bobbin, banding in accordance with the indicated voltages.

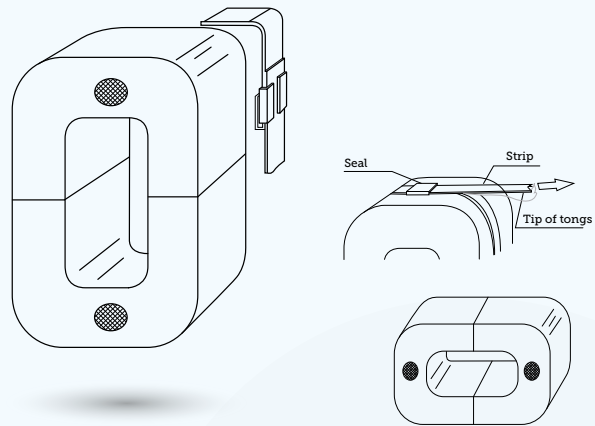

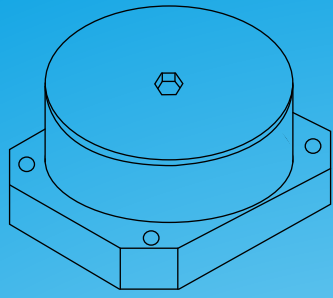

Toroid-based assemblies

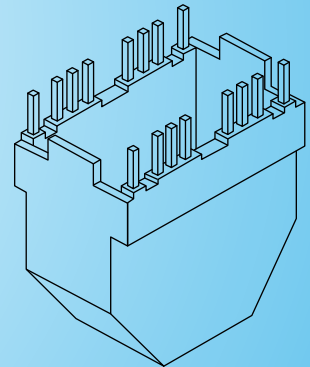
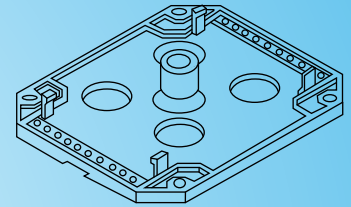
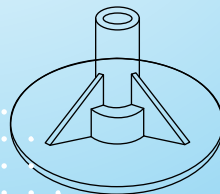
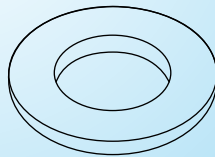
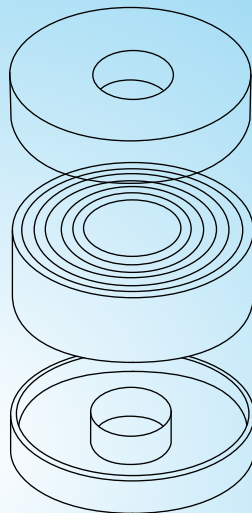
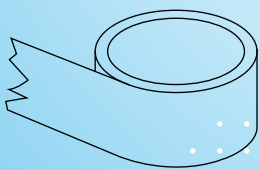
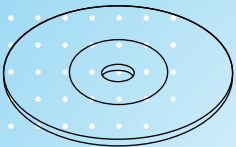
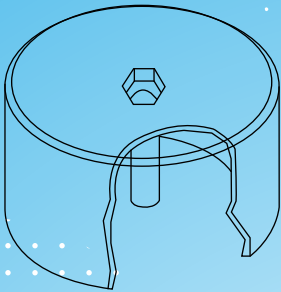

Toroid-based assemblies

GENERAL INFORMATION ABOUT TOROID CORES

→ Manufacturing method for toroid cores

Toroid cores are manufactured in the same way as C cores by winding grain oriented iron / silicon sheet metal and performing stress relief annealing.

No impregnation required (and no deterioration of the magnetic characteristics).
No air gap (the air gap consumes a lot of magnetizing current).

These advantages mean:

Lower load current in the windings of the "linear" type of iron + Mass better used iron weight = space saving compared to traditional transformers.
Decreased electromagnetic radiation allowing the use of this type of transformer in difficult environments.

The disadvantages:

Winding more difficult and lower speeds.
Insulation problems due to direct winding on the core.

→ Core/Winding insulation

BY INSULATING CUPELS

The cupels are 1/2 polyester lids for covering the core and insulating it (page 30).
Economical way with easy implementation, but all sizes are not available.

BY WRAPPING

Involves winding insulation tape around the core.
Economic to buy but has high added value.

BY COATING

The core is coated with a layer of insulating resin.
Isolectra Martin proposes a layer of epoxy resin deposited by fluidisation.
This technique allows excellent control of the thickness of the deposited layer, and a guarantee of the required insulation class.

Advantages of epoxy resins:

Stability over time
Good temperature stability:
Very good insulating properties
Isolectra Martin proposes a standard 3000 Vcc insulation, other insulating classes can be made on request.

Advantages of this process:

No advance preparation of the winding
Reduced obstruction
Adaptable to any size.
The higher purchase price is offset by the ease of use and time savings for the implementation of the transformer, and the fact of managing a single reference control product.
The guarantee of a core capable of meeting high electrical performance requirements.

→ Identification

Toroids

Sheet metal 0.30 - 0.10 - 0.05

TO = Bare toroids

TI = Impregnated toroids

TE = Coated toroids (3M epoxy resin)

TC = Cut toroids (saw blade thickness 1.6 or grinding wheel thickness 1.6)

TICE = Impregnated, cut, coated toroids

→ Rolled toroids

30/100 strip for 50 hz.

10/100 strip for 400 hz on request.

Toroids	D	d	L	Code	Cupels (*)
37 x 20 x 25	37.1	19.5	25	TO020357	IH 37 X 20
41 x 29 x 25	41.2	28.5	25	TO029376	IH 41 X 29
50 x 35 x 25	50.1	34.5	25	TO035412	IH 50 X 35
50 x 30 x 25	50.3	29.3	25	TO030409	IH 50 X 30
64 x 40 x 16	64.3	39.3	16	TO040462	
60 x 40 x 20	60.3	39.3	20	TO040446	IH 60 X 40
60 x 40 x 25	60.3	39.3	25	TO040447	IH 60 X 40
66 x 35 x 25	66.3	34.7	25	TO035472	IH 66 X 35
66 x 38 x 25	66.3	37.3	25	TO038047	IH 66 X 38
66 x 43 x 25	68.6	42.6	25	TO043478	IH 68 X 43
70 x 40 x 25	70.3	39.3	25	TO040053	IH 70 X 40
70 x 42 x 25	70.3	41.3	25	TO042484	IH 70 X 42
74 x 43 x 25	74.1	42.1	25	**	IH 74 X 43
80 x 46 x 25	80.1	45.2	25	TO046520	IH 80 X 46
80 x 50 x 25	80.1	49.2	25	TO050523	IH 80 X 50
80 x 50 x 32	80.1	49.2	32	TO050526	IH 80 X 50
86 x 50 x 25	86.4	49.2	25	TO050549	IH 80 X 50
88 x 52 x 25	88.4	51.2	25	TO052555	IH 88 X 52
100 x 60 x 32	100	60	32	TO060098	IH 100 X 60
100 x 60 x 40	100	60	40	TO060099	IH 100 X 60
125 x 71 x 40	125	71	40	TO071000	
120 x 71 x 51	125	71	51	TO071012	

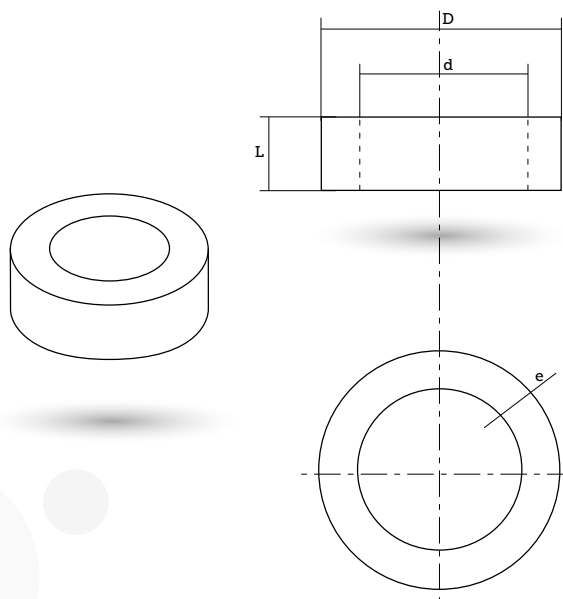

→ Guide list

Given the diversity of needs, there is no standard series concerning the products to date. The series shown below is an attempt at a guide list from the majority of requests.

Product specification directives

Toroids can be made in 30/100 and 10/100.

Five versions are possible

Impregnated - Non-impregnated - Protected by an epoxy layer - Cut - Coated impregnated cut

→ Winding thickness

30/100		10/100	
D	e max.	D	e max.
6	45	6	40
8	55	8	50
10	70	10	60
13	80	13	70
19	120	19	100
25 to 70	245	25 to 70	200

→ Choice of sizes

L strip width:

Between 6 and 250 mm

Preferred widths:

6 ; 8 ; 10 ; 13 ; 16 ; 19 ; 20 ; 22 ; 25 ; 29 ; 32 ; 38 ; 41 ; 44,5 48 ; 51 ; 54 ; 60 ; 70 ; 83 ; 102

Diameter D:

Limit higher than 750 mm

Diameter d:

D and e function

D 30/100		D 10/100	
d min.		d min.	
10	$D \leq 19$	6	$D \leq 13$
15	$19 \leq D \leq 51$	10	$13 \leq D \leq 13$
25	$51 \leq D \leq 70$	15	$19 \leq D \leq 70$
40	$40 \leq D \leq 102$	80	$70 \leq D \leq 200$

→ Toroids on request

To be defined jointly.

Reference definition of a core:

"d": minimum required internal diameter

"D": maximum required internal diameter

"L max": maximum core width

"L min": minimum core width

"e": minimum winding thickness

"T": tolerance on dimensions

COMMENT

Sizes on request.
Please contact the sales department by email: contact@isolectra.fr

Toroid-based assemblies

BOXES AND ACCESSORIES FOR TOROID CORES



Our partner **Weisser** proposes an extensive range of boxes and accessories for toroids.

We encourage you to consult the **www.weisser.de** website or pages 169 to 178 of the Weisser Catalogue in order to access the entire range.

VR - SMD
Box for toroids
Horizontal version

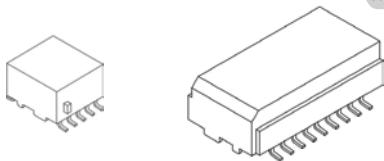

PAGE
169
Weisser
Catalogue

VDL
Box for toroids
Horizontal version

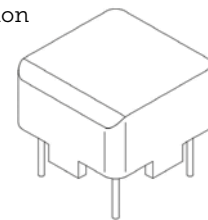

PAGE
169
Weisser
Catalogue

VDL
Box for toroids
Horizontal version

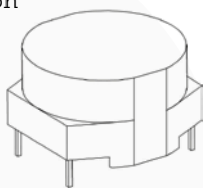

PAGE
170
Weisser
Catalogue

VRS
Box for toroids
Vertical version

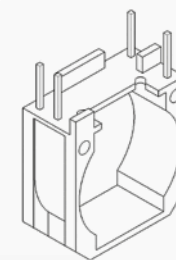

PAGE
170
Weisser
Catalogue

VR/PR
Box for toroids
Vertical version

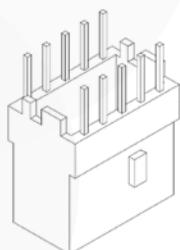

PAGE
171
Weisser
Catalogue

VR/PR
Box for toroids
Vertical version

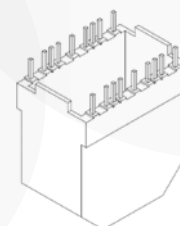

PAGE
171
Weisser
Catalogue

VR/PR
Box for toroids
Vertical version

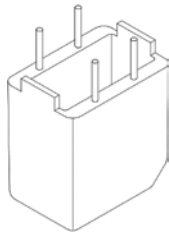

PAGE
172
Weisser
Catalogue

VR/SR
Box for toroids
with pin frame
Vertical version

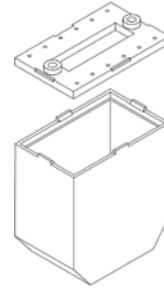

PAGES
172
173
Weisser
Catalogue

MH
Toroid mount
Horizontal version

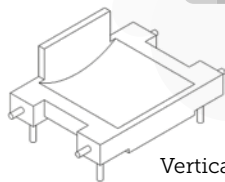
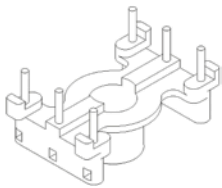

Vertical version

PAGE
173
Weisser
Catalogue

MR/DS
Mounting plate
with washer

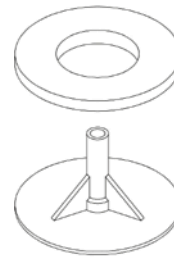

PAGE
174
Weisser
Catalogue

IH
Insulation covers
for toroids

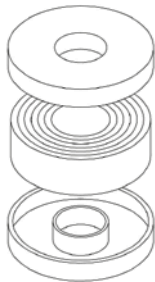

PAGE
175
Weisser
Catalogue

VR
Box for toroids

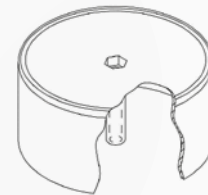

PAGE
176
Weisser
Catalogue

VR/UNI
Universal box
for toroids with
mounting clips

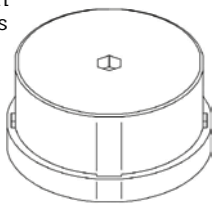

PAGE
177
Weisser
Catalogue

VR/ST
Box for toroids
and pin plates

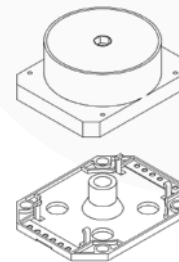

PAGE
178
Weisser
Catalogue

Toroid-based assemblies

TOROID CORES - BOXES - CUPELS - ACCESSORIES

→ Mounting flanges

Material: Zinc plated steel, on gross demand.

Our flanges are sold individually without fixing screws, insulators must be ordered separately.

d1	d2	d3	d4	L	White zinc plated steel		Zincore	
					Code	Ref.	Code	Ref.
35	15	11	4.5	3	D32001V1	85/1		85/1Z
51	19	11	4.5	4	D32005	85/5		85/5Z
65	23	13	6.5	6	D32002	85/2	D32202	85/2Z
78	34	17	8.5	9	D32003V1	85/3	D32203	85/3Z
115	45	21	10.5	12	D32004	85/4		85/4Z

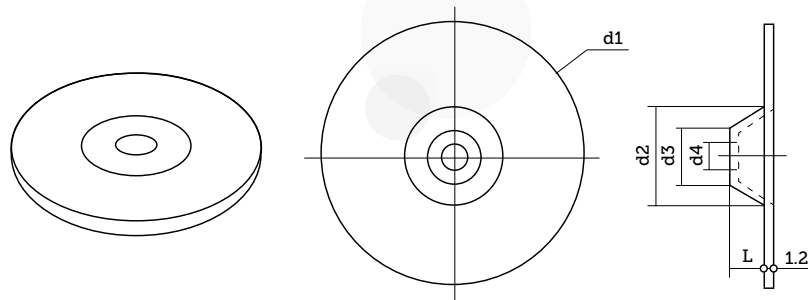

→ Black neoprene insulator

On request UL94V0 material insulator material or presspahn insulators.

d1	d2	ep	Code	Ref.
35	15	1	D32101	1
51	19	1	D32105	5
65	23	1	D32102	2
78	34	1	D32103	3
78	34	3	D32103V1	3
115	45	1	D32104	4

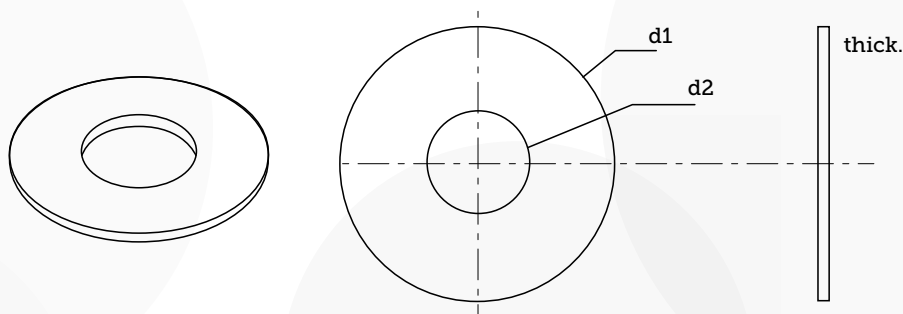



EI type lamination- based assemblies

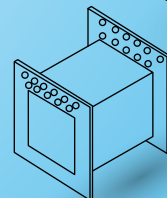
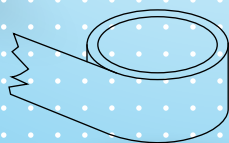
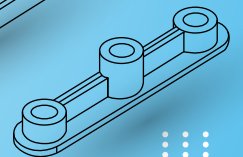
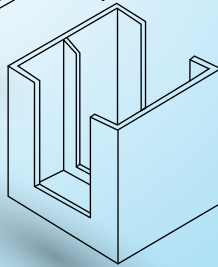
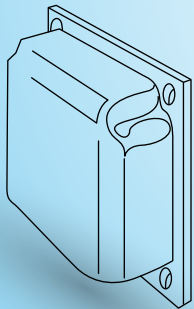
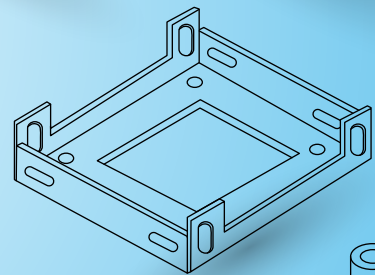
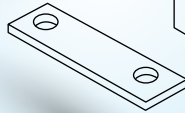
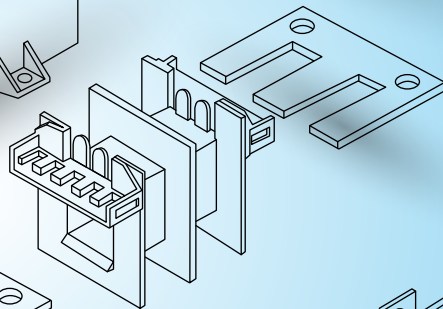
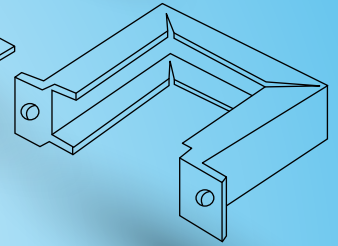
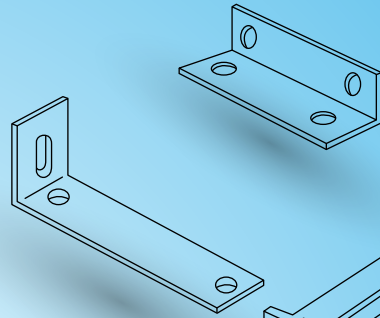
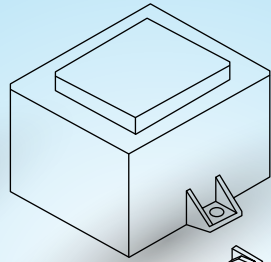
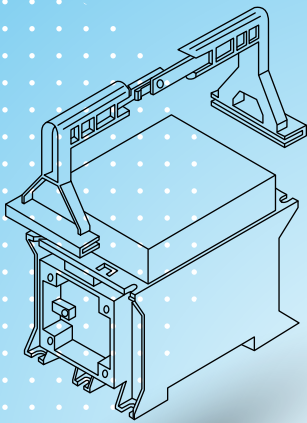

EI type lamination-based assemblies

GENERAL INFORMATION ON CUT LAMINATION

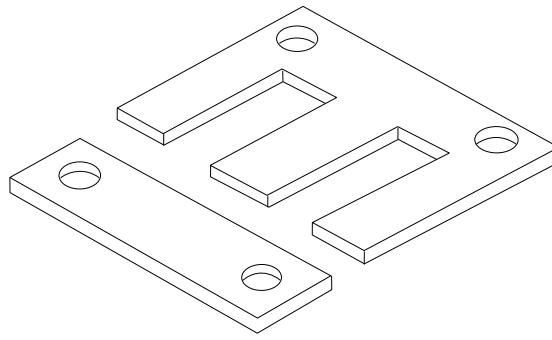

→ Technical data for lamination

Basic values: coefficient of expansion 0.94, density 7.65
Measures for induction 1.5 Tesla at 50 hz.

TYPE EI***	Magnetic length cm	Stacking cm	Iron section cm	Weight kg	Window cm	Volts per turn Volt	Total VA VA	Losses (iron) for 0.5 mm sheet metals					Volts per turn Sheet metal 0.35 mm	Total VA Sheet metal 0.35 mm	Max. iron losses 6 thick.
								2.6 W	2.3 W	1.7 W	1.5 W	1.35 W			
30	6	1	0.94	0.043	0.75	0.0313	2.6	0.31	0.28	0.2	0.17	0.16	0.035	3	0.12
38.4	7.7	1.28	1.54	0.09	1.23	0.051	5.5	0.65	0.58	0.42	0.36	0.34	0.058	6.3	0.25
42	8.4	1.37	1.74	0.112	1.47	0.058	6.8	0.81	0.74	0.52	0.45	0.42	0.065	7.8	0.31
44	9	1.37	1.74	0.13	1.76	0.058	7.9	0.94	0.85	0.6	0.52	0.49	0.065	9.1	0.36
48	9.6	1.57	2.3	0.17	1.92	0.077	10.3	1.23	1.11	0.78	0.68	0.65	0.086	11.9	0.47
52.5	10.5	1.75	2.88	0.225	2.3	0.096	13.6	1.62	1.46	1.04	0.9	0.85	0.108	15.75	0.63
54	10.8	1.77	2.94	0.243	2.43	0.098	14.7	1.75	1.58	1.12	0.97	0.92	0.111	17	0.68
60	12	1.99	3.7	0.34	3	0.123	20.6	2.45	2.21	1.56	1.36	1.29	0.139	23.8	0.95
66	13.2	2.19	4.46	0.45	3.63	0.149	27.2	3.24	2.93	2.07	1.81	1.71	0.168	31.5	1.26
75	15	2.5	5.86	0.663	4.69	0.195	40	4.77	4.31	3.05	2.66	2.52	0.221	46.4	1.86
78	15.6	2.64	6.4	0.76	5.07	0.213	46	5.47	4.94	3.5	3.05	2.89	0.241	53.2	2.13
84	16.8	2.79	7.2	0.93	5.88	0.240	56	6.7	6	4.28	3.74	3.53	0.271	65	2.6
96	19.2	3.4	10.1	1.48	7.68	0.336	90	10.66	9.6	6.8	5.96	5.6	0.381	104	4.14
108	21.6	3.6	12.18	1.98	9.72	0.406	120	14.26	12.9	9.11	7.97	7.53	0.459	139	5.54
120	24	4	14.8	2.72	12	0.493	165	19.58	17.7	12.5	10.95	10.3	0.558	190	7.6
126	25.2	4.2	16.58	3.16	13.23	0.552	191	22.75	20.54	14.54	12.72	12	0.625	221	8.85
135	27	4.5	19.04	3.85	15.19	0.634	233	27.72	25	17.71	15.5	14.63	0.718	270	10.78
150n	30	4.79	22.2	5.1	18.75	0.739	309	36.72	33.2	23.5	20.53	19.4	0.837	357	14.3
180	36	6	33.84	9.2	27	1.127	556	66.24	59.8	42.32	37.03	35	1.277	644	25.75
210	42	7	46.06	14.55	36.75	1.534	879	104.76	94.6	66.93	58.56	55.3	1.738	1018	40.74
240	48	8	60.16	21.75	48	2.003	1314	156.6	141.4	100.05	87.54	82.65	2.27	1523	60.9

→ Technical characteristics

PERMEABILITY

Permeability, f = 50 hz, EPSTEIN tests

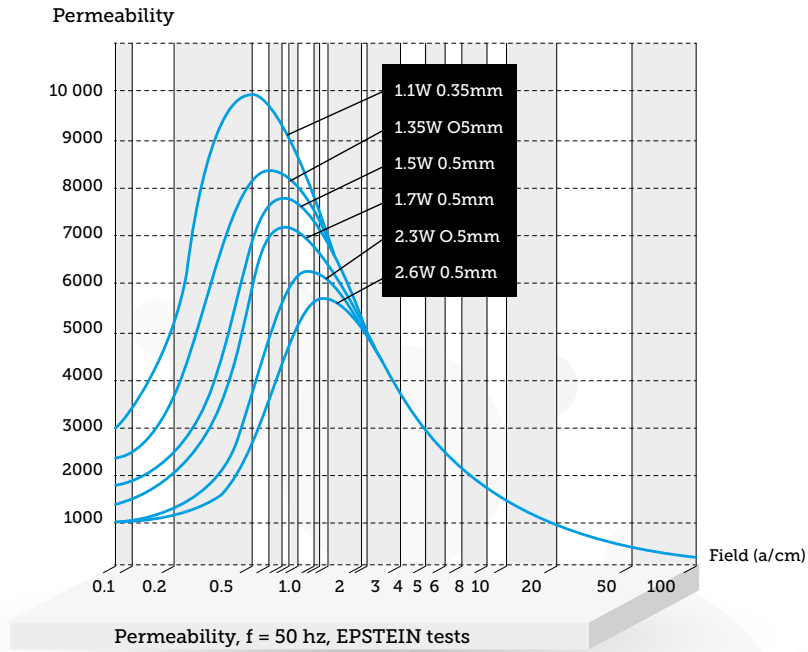

INDUCTION

Losses W/Kg at f = 50 hz for 0.5 mm sheet metals

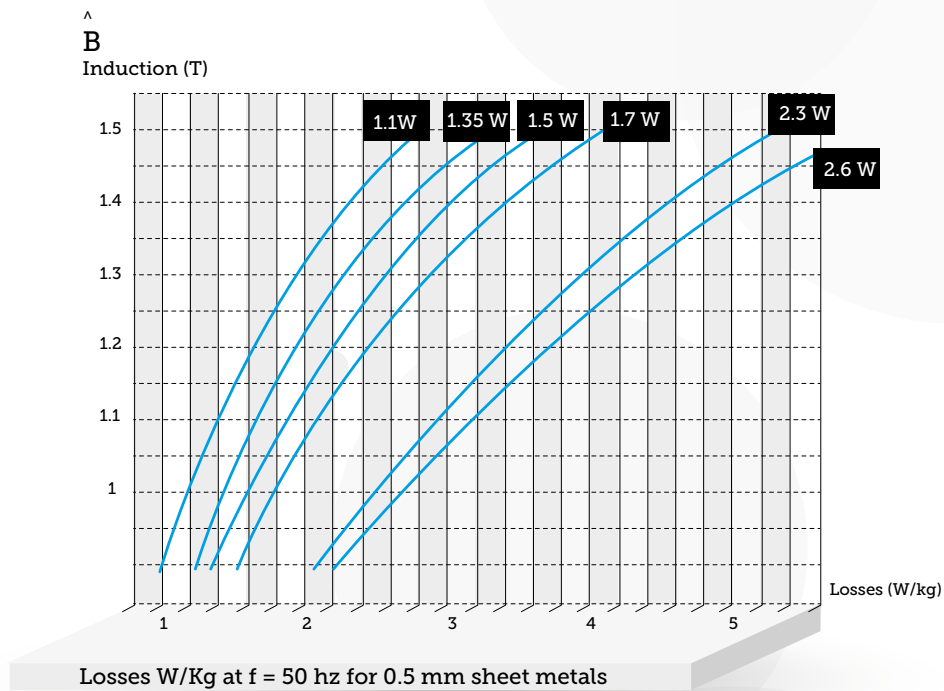

EI type lamination-based assemblies

SINGLE/THREE-PHASE EI LAMINATIONS

→ EI single-phase lamination

Type	A	B	C	D	E	F	G	I	K	kg% 5/10	0.35	Code			
												0W6	1W3	1W6 1W7	2W6 2W7
EI 15	15	8	2	.	6	4	11	.	.	.	0.289	C18105*			(2)
EI 19	19.05	13.49	2.38	0.79	11.11	4.76	14.28	.	.	.	0.529	C18107V1			(2)
EI 25.4	25.4	15.94	3.2	1.5	12.7	6.35	19.04	.	.	.	0.88	C18109V1			(2)
EI 30	30	20	5	.	15	10	20	.	.	2.31	1.6	C15555	C15505		(1)
EI 32	32	23.2	4.5	.	19	9	23	.	.	2.42	1.68	C18111		C18113	(1)
EI 38	38	25.6	6.4	.	19.2	12.8	25.6	.	.	3.78	2.63	C15556	C15506		(1)
EI 42	42	28	7	3.5	21	14	28	35	24.5	4.38	3.04	C15557	C15507		(1)
EI 44	44	30	7	.	22	14	30	.	.	4.7	3.27	C18245		C18225	C18205 (1)
EI 48	48	32	8	3.5	24	16	32	40	28	5.76	4.01	C15558	C15508		(1)
EI 52.5	52.5	35	8.75	9.5	26	17.5	35	43.75	30.7	6.6	4.62	C18246		C18226	C18206 (1)
EI 54	54	36	9	3.5	27	18	36	45	31.5	7.33	5.1	C15559	C15509		(1)
EI 60	60	40	10	3.5	30	20	40	50	35	9.09	6.32	C18247	C15514	C18227	C18207 (1)
EI 66	66	44	11	4.5	33	22	44	55	38.5	10.93	7.6	C15560	C15510		(1)
EI 75	75	50	12.5	4.5	37.5	25	50	62.5	43.75	14.19	9.87	C18248		C18228	C18208 (1)
EI 78	78	52	13	4.5	39	26	52	65	45.5	15.37	10.7	C15561	C15511		(1)
EI 84	84	56	14	4.5	42	27	56	70	49	17.86	12.42	C18249		C18229	C18209 (1)
EI 96	96	64	16	5.5	48	32	64	80	56	23.29	16.2	C18250		C18230	C18210 (1)
EI 105	105	70	17.5	5.5	52.5	35	70	87.5	61.25	27.93	19.42	C15562	C15512		(1)
EI 108	108	72	18	5.5	54	36	72	90	63	29.57	20.56	C18251		C18231	C18211 (1)
EI 120	120	80	20	6.6	60	40	80	100	70	36.43	25.34	C15563	C15513		(1)
EI 126	126	84	21	6.5	63	42	84	105	73.5	40.24	27.98	C18252		C18232	C18212 (1)
EI 150	150	100	25	8	75	50	100	125	87.5	56.97	39.62	C18253		C18233	C18213 (1)
EI 180	180	120	30	8.5	90	60	120	150	105	82.29	57.23	C18254		C18234	C18214 (1)
EI 240	240	160	40	11.5	120	80	160	200	140	146.24	101.705	C18255		C18235	C18215 (1)

Fig. 1

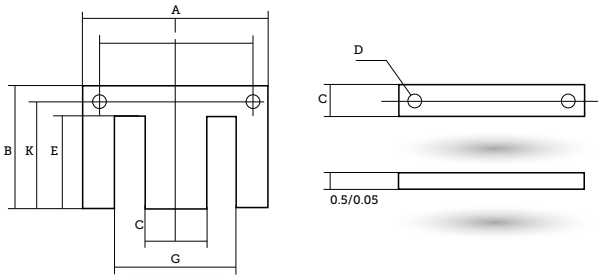
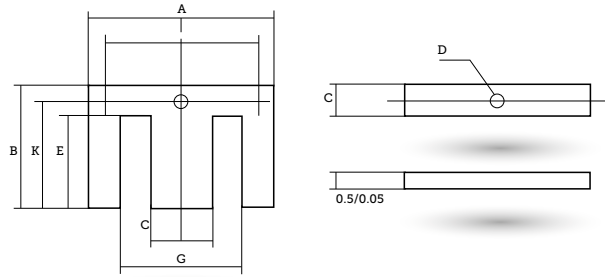
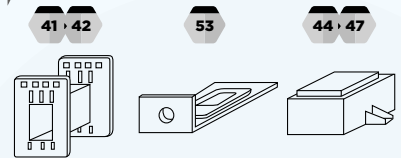

Fig. 2



0W6: annealed
1W3 to 1W7: varnished
Mini. conditioning:
- one bar
- one charger
- one box (depending on size)

ADDITIONAL PRODUCTS



→ EI three-phase lamination

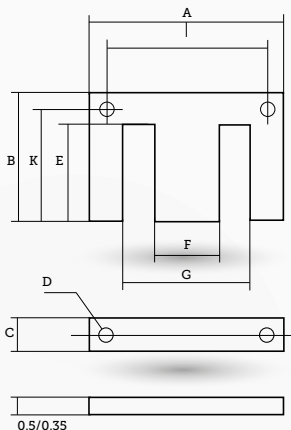

0W6: annealed
1W7: varnished

Type EI**	Type 3 UI	A	B	C	D	E	I	K	G	kg% 5/10	kg% 35/100	Code		
												0W6	1W7	2W3
50/50	30	50	40	10	3.5	30	40	35	30	7.16	4.98	C15101		
65/65	39	65	52	13	3.5	39	52	45.5	39	12.21	8.5	C15102		
80/80	48	80	64	16	4.5	48	64	56	48	18.36	12.77	C15103		
100/100	60	100	80	20	5.5	60	80	70	60	28.71	19.97	C15104	C15153	
125/125	75	125	100	25	5.5	75	100	87.5	75	44.83	31.18	C15105	C15154	
150/150	90	150	120	30	8.5	90	120	105	90	64.53	44.88	C15106	C15155	
170/170	102	170	136	34	8.5	102	136	119	102	83.25	58.65			
175/175	.	175	140	35	10.5	105	140	122.5	105	87.61	60.93	C15107	C15156	
190/190	114	190	152	38	11	114	152	133	114	103.43	71.93			
200/200	.	200	160	40	11	120	160	140	120	114.85	79.87	C15108	C15157	
220/220	132	220	176	44	11	132	176	154	132	139.42	96.96	C15109	C15158	
240/240	.	240	192	48	11	144	192	168	144	166.35	115.69			
250/250	150	250	200	50	11	150	200	175	150	180.68	125.65	C15110	C15159	
280/280	168	280	224	56	11	168	224	196	168	225.32	156.7	C15111	C15160	
300/300	180	300	240	60	11	180	240	210	180	258.1	179.5	C15112	C15162	
350/350	210	350	280	70	15	210	280	245	210	351.89	244.72	C15113	C15163	C15166
400/400	240	400	320	80	19	240	320	280	240	461.62	321.03	C15114	C15164	C15167
500/500	.	500	400	100	21	300	400	350	300	723.49	503.16	C15115	C15165	



Our partner **Weisser** proposes an extensive range of products for EI mounting.

We encourage you to consult the **www.weisser.de** website or pages 25 to 106 of the Weisser Catalogue in order to access the entire range.

OD (DIN 41 305)
EI 38 - EI 192

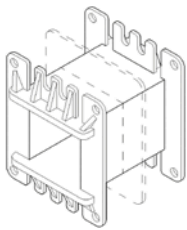

PAGES

25

27

Weisser Catalogue

INFO:

Explanation:
Bobbins for 3-phase lamination

PAGE

28

Weisser Catalogue

MS
with mounting rails
EI 60 - EI 150 N

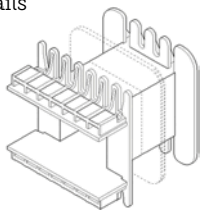

PAGE

29

Weisser Catalogue

MS
with mounting rails
EI 60 - EI 192

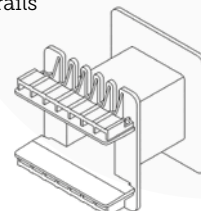

PAGES

30

31

Weisser Catalogue

LP (DIN 41 305)
EI 42 - EI 130

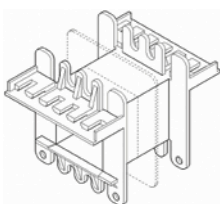

PAGES

32

33

Weisser Catalogue

INFO:

Explanation:
Bobbins for RAST-5 technology

PAGE

34

Weisser Catalogue

EI type lamination-based assemblies

VARIOUS PRODUCTS FOR EI MOUNTING

ST-R5 (RAST-5)
EI 48 - EI 84

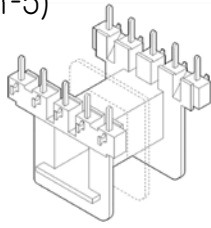

PAGE
35
Weisser
Catalogue

ST
EI 42 - EI 54

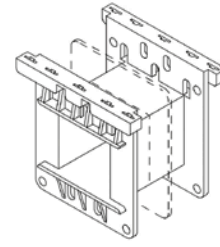

PAGES
36
37
Weisser
Catalogue

ST (FORM O)
EI 60 - EI 96

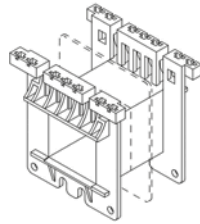

PAGES
38
39
Weisser
Catalogue

ST (FORM G)
EI 60 - EI 96

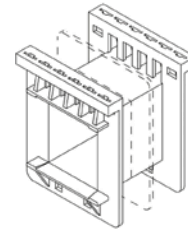

PAGES
40
42
Weisser
Catalogue

SI/II-IS
EI 66 - EI 96

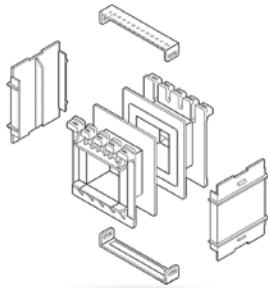

PAGES
43
44
Weisser
Catalogue

ST/II-HK
(one-piece bobbin)
EI 66

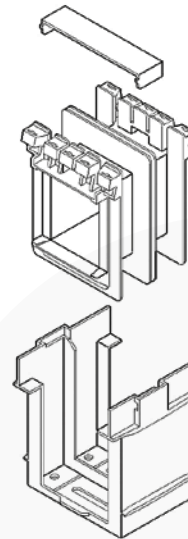

PAGE
44
Weisser
Catalogue

ST/II-HVD "T" TYPE
EI 66 - EI 78

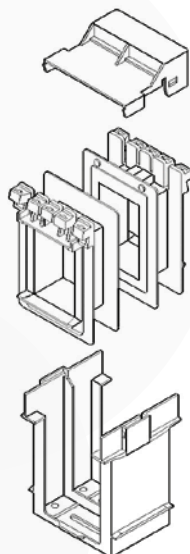

PAGE
45
Weisser
Catalogue

ST/II-HK "T" TYPE
EI 78

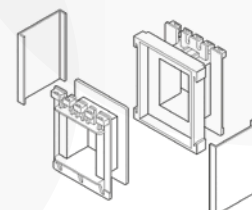

PAGE
45
Weisser
Catalogue

ST/II-HK T" TYPE
EI 66 - EI 96

PAGES
46
47
Weisser
Catalogue

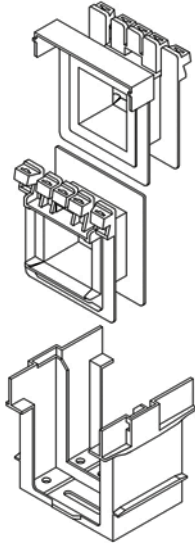

SI/II-HD
EI 66 - EI 120

PAGES
48
49
Weisser
Catalogue

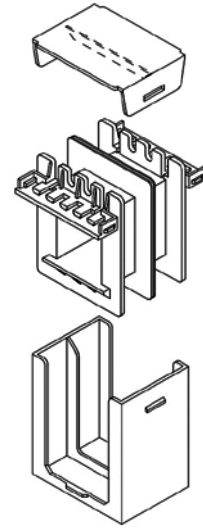

SI/II-VT
EI 30

PAGE
50
Weisser
Catalogue

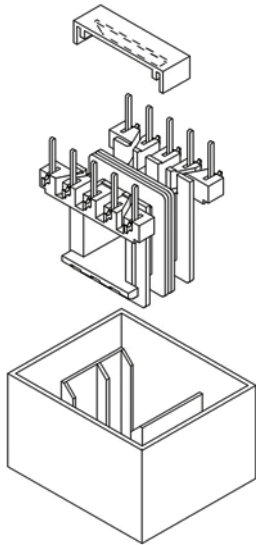

SI/II-HD
with shrouds for wire protection
EI 30 - EI 66

PAGES
50
56
Weisser
Catalogue

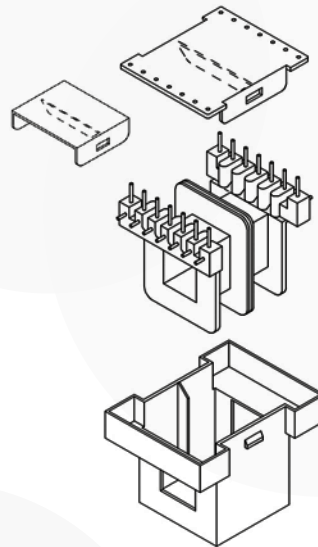

EI type lamination-based assemblies

VARIOUS PRODUCTS FOR EI MOUNTING

ST/II-HD
with shrouds for terminal protection
EI 48 - EI 66

PAGES
57
Weisser
Catalogue

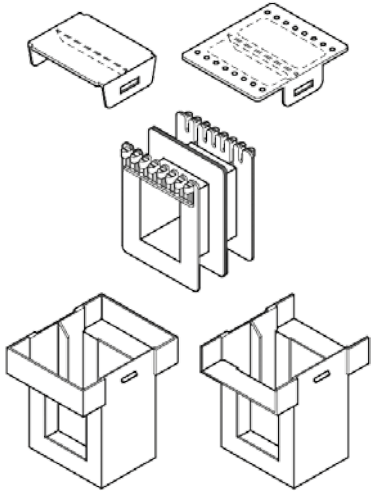

INFO:
Explanation:
Safety class bobbins with fixing
cover

PAGE
60
Weisser
Catalogue

ST/SII-BD
with shrouds
for wire protection

PAGE
61
Weisser
Catalogue

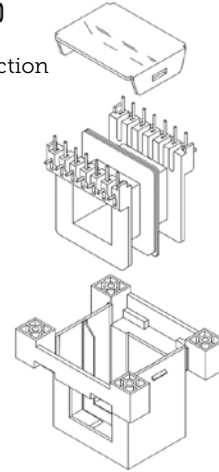

ST/II-HD
with shrouds for terminal protection

PAGE
62
Weisser
Catalogue

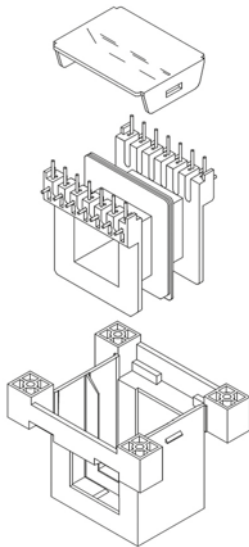

"O" TYPE BOX
EI 30 - EI 120

PAGES
64
65
Weisser
Catalogue

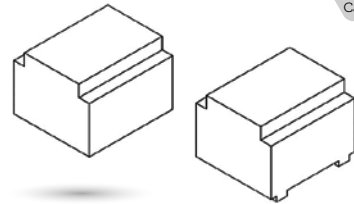

"O" TYPE BOX
EI 30 - EI 38

PAGE
64
Weisser
Catalogue

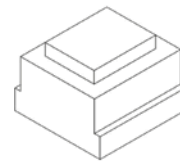

"K" TYPE BOX
with fixings
EI 30 - EI 54

PAGE
66
Weisser
Catalogue

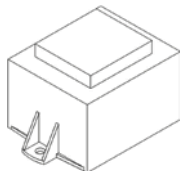

"I" TYPE BOX
with fixings
EI 30 - EI 48

PAGE
66
Weisser
Catalogue

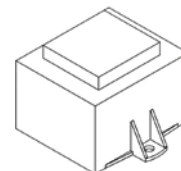

"KK" TYPE BOX
with fixings
EI 54 - EI 120

PAGES
67
68
Weisser
Catalogue

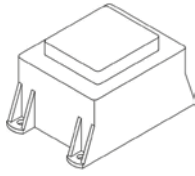

BASE PLATES
with fixings
EI 60 - EI 120

PAGE
69
Weisser
Catalogue

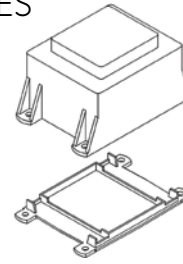

BOX
for DIN rail assembly
EI 48 - EI 78

PAGE
70
Weisser
Catalogue

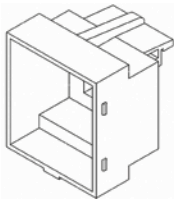

BOX
with handle
EI 96

PAGES
71
73
Weisser
Catalogue

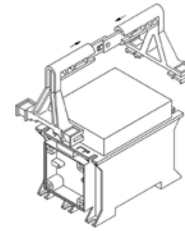

ADAPTER

PAGE
73
Weisser
Catalogue

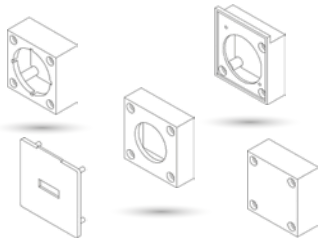

BOX
with handle
EI 120

PAGE
74
Weisser
Catalogue

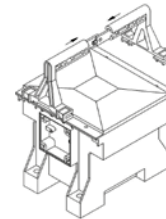

BOX
or vertical version
"SV" type
EI 38 - EI 96

PAGE
75
Weisser
Catalogue

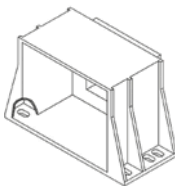

BOX
for vertical version
"SV R5" type
EI 48 - EI 84

PAGE
76
Weisser
Catalogue

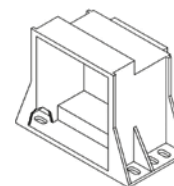

INFO:
Explanation:
Connection frame and lid for spray
protected version according to IP 54

PAGE
78
Weisser
Catalogue

BOX
or vertical version
"SV HA" type
EI 84 - EI 120

PAGE
79
Weisser
Catalogue

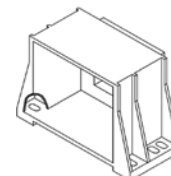

EI type lamination-based assemblies

VARIOUS PRODUCTS FOR EI MOUNTING

CONNECTING FRAME LID
AND GASKET
EI 84 - EI 120

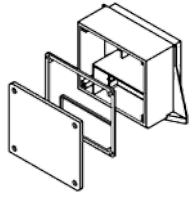

PAGES
80
81
Weisser
Catalogue

LOW PROFILE VERSION
with moulded-in pins
EI 30 - EI 54

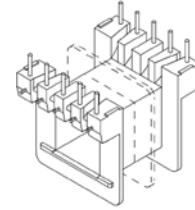

PAGE
85
Weisser
Catalogue

LOW PROFILE VERSION
with pins
EI 42 - EI 66

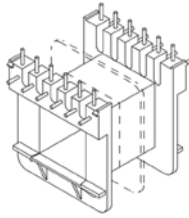

PAGES
86
87
Weisser
Catalogue

LOW PROFILE VERSION
with pins
EI 30 - EI 42

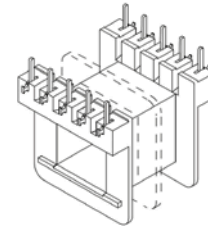

PAGES
88
89
Weisser
Catalogue

LOW PROFILE VERSION
for terminals
EI 30 - EI 66

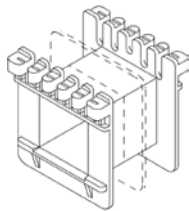

PAGES
90
91
Weisser
Catalogue

"O" TYPE BOX
EI 19

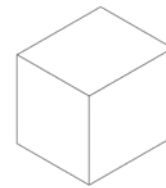

PAGE
92
Weisser
Catalogue

"O" TYPE BOX
EI 30 - EI 38

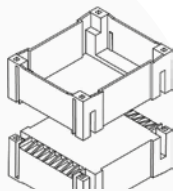

PAGE
92
Weisser
Catalogue

"O" TYPE BOX
EI 30 - EI 78

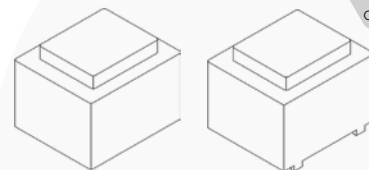

PAGES
92
94
Weisser
Catalogue

"K" TYPE BOX
with moulded-in pins
EI 38 - EI 60

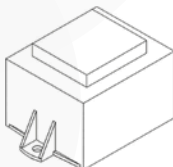

PAGE
94
Weisser
Catalogue

"KK" TYPE BOX
with moulded-in pins
EI 54 - EI 66

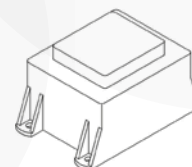

PAGE
95
Weisser
Catalogue

"SV" TYPE BOX
for vertical version
EI 48 - EI 66

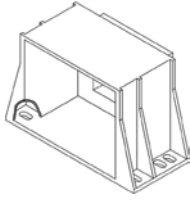

PAGE
95
Weisser
Catalogue

OD
EI 66/88 - EI 84/112

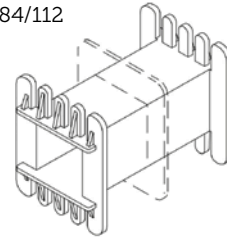

PAGE
99
Weisser
Catalogue

LP/II-HD
EI 54/72 - EI 78/104

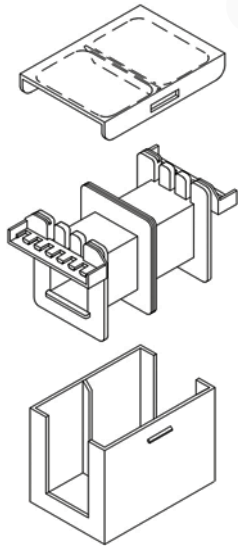

PAGES
101
102
Weisser
Catalogue

LP
EI 66/88 - EI 84/112

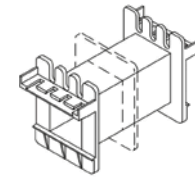

PAGES
99
100
Weisser
Catalogue

INFO:
Explanation:
I with elongated limb

PAGE
103
Weisser
Catalogue

"O" TYPE BOX
EI 30/40

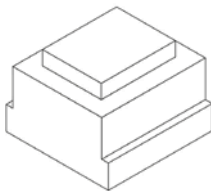

PAGE
104
Weisser
Catalogue

"KK" TYPE BOX
with moulded-in pins
EI 54/72 - EI 84/112

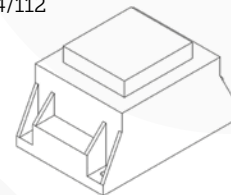

PAGE
105
Weisser
Catalogue

BASE PLATES
EI 54/72 - EI 84/112

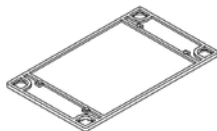

PAGE
105
Weisser
Catalogue

EI type lamination-based assemblies

BOBBINS

→ Bobbins for EI cores

b1	h1	b2	h2	l1	l2	l3	n	k1	k	V	W	X	Type	Code	Ref.	EI core
4.2	6.3	10.8	14.2				0.5	3.4	3.5	5.08	7.62	3x2	9	A01103	flat pins	64 PP 15/6
4.2	6.3	11	14.2							5	7	3x2	9	A01104	flat pins	64 PR 15/6
5.3	5.3	15.7	15.8	9.8	10.8		0.5	5.1	3.5	5.08	10.16	3x2	2	A01106	flat pins	55 19.2/5
5.2	5.2	14	14	9.8	10.8		0.5	5	4	5	10.16	3x2	10	B66441	round pins	19/8/5 ULV0
5.3	7.3	15.6	17.5	9.8	13.8		0.5	5.1	3.5	5.08	10.16	3x2	2	A01109P	flat pins	57 PP 19.2/7
5.3	7.4	15.5	17.5	9.7	14.2					5	10	3x2	2	A01108	round pins	57 PR 19.2/5
5	5	15	15	9.9	13		1.2	5	3.5				6	A01112		110 19.2/5
5.3	7.4	15.8	17.5	10	13		0.85	5.25	5.05				6	A01115		110 B 19.2/7
7	9	21.6	22	11	12		0.5	7.5	3.5	5.08	15	4x2	1	A01118	flat pins	79 25.6/9
16.5	16.5	31.5	31.5	21.5	23.5		1	7.5	7.5				3	A01127		82 P.T.T.
12.8	16	29	30.5	27	29		1	7.3	7.2				6	A01130		116 P.T.T. No.2
7.5	7.5	16.7	17	16.4	18		0.8	4.8	4				6	A01133		92 P.T.T. No.3
9.2	9.2	22.5	25.3	16.5	18.5		1.5	6.6	5.5	5.08	20.32	5x2	9	A01139	flat pins	992 32/9
9.2	14	22.3	30.3	16.5	18.5		1.5	6.6	5.5	5.08	20.32	5x2	9	A01142	flat pins	914 32/14
9.2	9.2	21.3	21.3	16	18		1	5.5	5.1				3	A01145		111 32/9
9.2	9.2		same with middle flange										3	A01148		111 B 32/9
9.2	13.5		same with middle flange										3	A01154		112 B 32/13
9.2	14	22	27.5	16.5	18.5		1	6.7	5.1				4	A01157		113 32/14
9.2	14	22	33	16.5	20		1	6.7	5.1				5	A01160		114 32/14
9.2	9.2	21.2	21.2	16.5	18.5		1	6	5.1				6	A01163		115 32/9
14.8	15	28.5	28.5	19.4	21		0.8	7	6				3	A01166		140 44/15
14.8	15		same with middle flange										3	A01169		140 B 44/15
15	17	29	33	19	21		1	7	6				3	A01172		141 44/17
15	17	29	41.5	19	21		1	9.8	6				7	A01175		141 B 44/17
15	17	29	32	19	21		1	7.5	6				3	A01178		141 DJI 52.5/18
18	18	34.2	34.2	24	26	32	1	8	7				3	A01181		142 F 52.5/18
18	18		same with middle flange										3	A01184		3142 AJI 52.5/18
18	18	34.2	34.2	24	26		1	8	7				3	A01187		142 V 52.5/18
18	18	34.1	44	24	26	32	1	8	7				8	A01190		142 B 52.5/18
18	18		same with middle flange										8	A01193		142 C 52.5/18
18.5	20.5	42	46	24	26		1	10	6				8	A01196		143 52.5/20.5

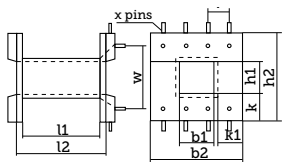

Type 1

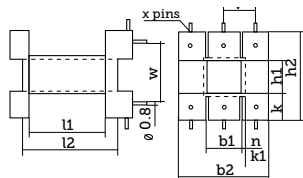

Type 2

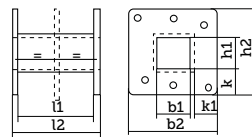

Type 3

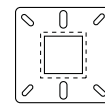

Type 4

ADDITIONAL PRODUCTS

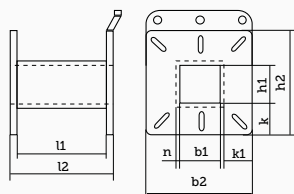
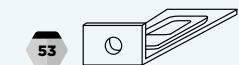
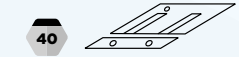

Type 5

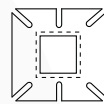

Type 6

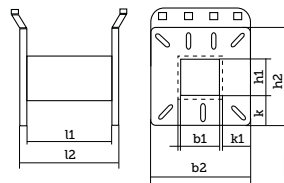

Type 7

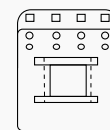

Type 8

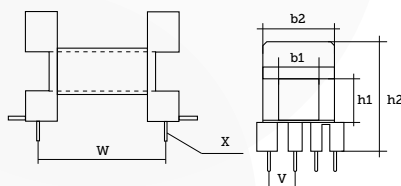

Type 9

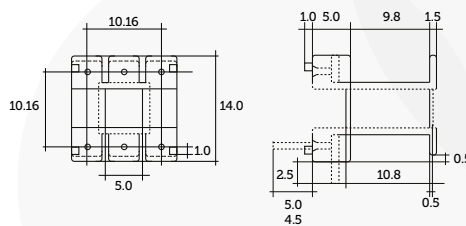

Type 10

→ EI Slot bobbins - Free wire outputs

A	B	M	N	C	D	H	SP	P	Code S = 1	Code S = 2	Circuit	Ref S=1	Ref S = 2
42	42	81.6	88.4	62.6	27.3	29.5	1.7	68	A31201V2	A31202V2	EI 126/42	2000	2006
42	50	81.6	97	62.6	27.3	29.5	1.7	68	A31301V2	A31302V2	EI 126/50	2001	2007
42	60	81.6	106.2	62.6	27.3	29.5	1.7	68	A31401V2	A31502V2	EI 126/60	2002	2008
42	70	81.6	115.8	62.6	27.3	29.5	1.7	68	A31501V2	A31502V2	EI 126/70	2003	2009
42	80	81.6	126	62.6	27.3	29.5	1.7	68	A31601V1	A31602V2	EI 126/80	2004	2010
42	90	81.6	132	62.6	27.3	29.5	1.7	68	A31701	A31702	EI 126/90	2005	2011

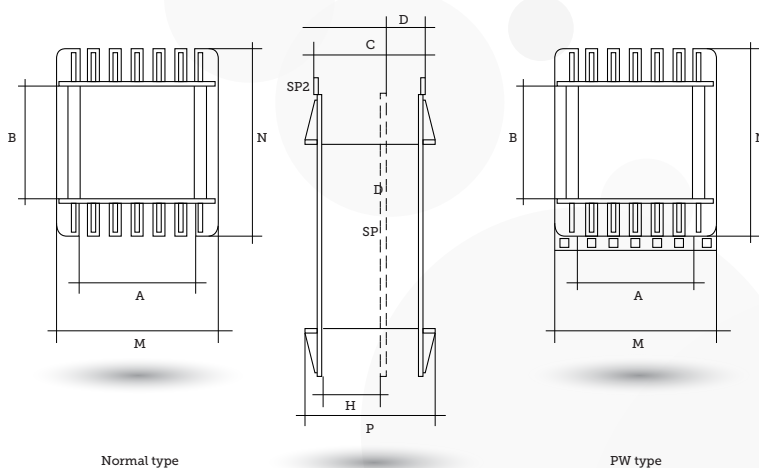

EI type lamination-based assemblies

BOBBINS

→ Open slot bobbins - Output crimp terminals

b1	h1	b2	h2	k	k1	l1	l2	l3	l4	Code S = 1	Code S = 2	Designation	Ref. S = 1	Ref. S = 2
21	21	39.5	50.5	10	8	26.4	29.00	29	29	A02103	A02104	EI 60/21	102*	102JI
21	26	39.5	55	10	8	26.4	29.00	29	29	A02106	A02107	EI 60/26	103*	103JI
21	30	39.5	59.5	10	8	26.4	29.00	36.5	36.5	A02109	A21010	EI 60/30	104*A	104AJI
21.3	21.3	39	39	9	7.9	27	29.00			A02121	A02122	EI 60/21.3	144*	144JI
21.5	21.5	38.6	47	8.4	7.9	27	29.00			A02124		EI 60/21.5	145*	145JI
20.8	20.4	40	48	9.5	7.9	26.6	29.00			A02126		EI 60/20.4	146*	146JI
21	21	38	47	8.6	7.9	27	29.00			A02128		EI 60/21	147*	147JI
21	26	39	55	9	7.9	27	29.00			A02130		EI 60/26	148*	148JI
21	35	39.5	64.5	10	8	26.4	29.00		36.5	A02112		EI 60/35/* OD	104*B	104BJI
20.6	40	39.1	51.7	9.1	8.4	26.8	29.00		36.5	A02115		EI 60/40	105*	
20.6	42	39.1	51.7	9.1	8.4	26.8	29.00		36.5	A02118		EI 60/42	106*	
26	21	49	58	14	10	34	37		42.5	A02203	A02204	EI 75/21	118*	118JI
26	26	49	59	15	10	34	37		42.5	A02206	A02207	EI 75/26	119*	119JI
26	26	49	58	12	10	35	37			A02209		EI 75/26	119C*	
26	26	49	63	14	10	34	37		42.5	A02211		EI 75/26	119GD*	
26	30	49	67	14	10	34	37		42.5	A02213	A02214	EI 75/30	120*	120JI
26	32	49	69	14	10	34	37		42.5	A02216	A02217	EI 75/32	121*	121JI
26	35	49	72	14	10	34	37		42.5	A02219	A02220	EI 75/35	122*	122JI
26	38	49	75	14	10	34	37		42.5	A02222		EI 75/38	123*	
26	40	49	77	14	10	34	37		42.5	A02225	A02226	EI 75/40	124*	124JI
26	45	49	82	14	10	34	37		42.5	A02228		EI 75/45	125*	
26	50	49	87	14	10	34	37		42.5	A02231	A02232	EI 75/50	126*	126JI
26	60	49	97	14	10	34	37			A02234		EI 75/60	127*	
26	70	49	107	14	10	34	37			A02236		EI 75/70	128*	
29	29	55	68	15	14.5	37.9	41.5		47	A02303	A02305	EI 84/29	151*	151JI
29	32	55	71	15	11.5	37.9	41.5		47	A02307		EI 84/29	152*	
29	34	55	73	15	11.5	37.9	41.5		47	A02310	A02311	EI 84/34	153*	153JI
29	36	55	75	15	11.5	37.9	41.5		47	A02313	A02314	EI84/36	154*	154JI
29	40	55	79	15	11.5	37.9	41.5		47	A02316	A02317	EI 84/40	155*	155JI
29	44	55	83	15	11.5	37.9	41.5		47	A02319	A02320	EI 84/44	156*	156JI
29	46	55	86	16	11.5	37.9	41.5		47	A02322		EI 84/46	157*	
29	50	55	89	15	11.5	37.9	41.5		47	A02325	A02326	EI 84/50	158*	158JI
29	56	55	96	15	11.5	37.9	41.5		47	A02328	A02329	EI 84/56	159*	159JI
29	70	55	109	15	11.5	37.9	41.5		47	A02331		EI 84/70	159B*	
29	80	55	119	15	11.5	37.9	41.5		47	A02334		EI 84/80	160*	
33	19.5	62.5	61.5	17	13	44.1	47.5		53.3	A02403	A02404	EI 96/19.5	199*	199JI
33	25	62.5	67	17	13	44.1	47.5		53.3	A02406	A02407	EI 96/25	200*	200JI
33	30	62.5	72	17	13	44.1	47.5		53.3	A02409	A02410	EI 96/30	201*	201JI
33	34	62.5	76	17	13	44.1	47.5		53.3	A02412	A02413	EI 96/34	202*	202JI
33	40	62.5	82	17	13	44.1	47.5		53.3	A02415	A02416	EI 96/40	203*	203JI
33	45	62.5	87	17	13	44.1	47.5		53.3	A02418	A02419	EI 96/45	204*	204JI
33	47.5	62.5	89.5	17	13	44.1	47.5		53.3	A02421	A02422	EI 96/47.5	204B*	204BJI
33	50	62.5	92	17	13	44.1	47.5		53.3	A02424		EI 96/50	205*	
33	56	62.5	98	17	13	44.1	47.5		53.3	A02427		EI 96/56	206*	
33	63	62.5	105	17	13	44.1	47.5		53.3	A02430	A02431	EI 96/63	207*	207JI
33	71	62.5	113	17	13	44.1	47.5		53.3	A02433	A02434	EI 96/71	208*	208JI
37	30	70	76	19	17	49.5	53.50		58.5	A02503		EI 108/30	249*	
37	37	70	83	19	17	49.5	53.50		58.5	A02506	A02507	EI 108/37	251*	251JI
37	42	70	88	19	17	49.5	53.50		58.5	A02509	A02510	EI 108/42	251B*	251BJI
37	47	70	93	19	17	49.5	53.50		58.5	A02512	A02513	EI 108/47	252*	252JI
37	50	70	96	19	17	49.5	53.50		58.5	A02515	A02516	EI 108/50	252B*	252BJI
37	55	70	101	19	17	49.5	53.50		58.5	A02518	A02519	EI 108/55	253*	253JI
37	60	70	107	19	17	49.5	53.50		58.5	A02521	A02522	EI 108/60	254*	254JI
37	65	70	107	19	13	49.5	53.50		58.5	A02524	A02525	EI 108/65	254A*	254AJI
37	70	70	116	19	17	49.5	53.50		58.5	A02527		EI 108/70	254B*	254BJI
37	72	70	118	19	17	49.5	53.50		58.5	A02530	A02531	EI 108/72	255*	255JI
42	42	81.6	96.4				62.6		68	A32201V2	A32202V2	EI 126/42/PW	2012	2018
42	50	81.6	103.5				62.6		68	A32301V2	A32302V2	EI 126/50 /PW	2013	2019
42	60	81.6	113.8				62.6		68	A32401V2	A32402V2	EI 126/60 /PW	2014	2020
42	70	81.6	123.8				62.6		68	A32501V2	A32502V2	EI 126/70 /PW	2015	2021
42	80	81.6	134				62.6		68	A32601V1	A32602V1	EI 126/80 /PW	2016	2022
42	90	81.6	140				62.6		68	A32701	A32702	EI 126/90 /PW	2017	2023

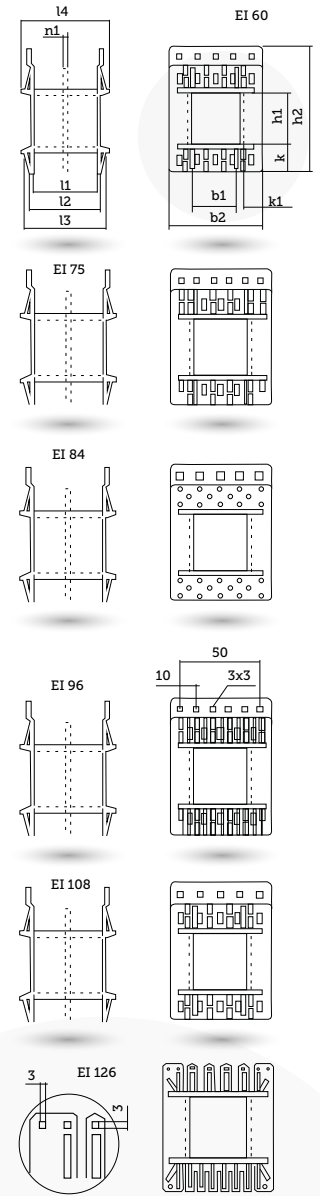

ADDITIONAL PRODUCTS

S = 1: Without intermediate panel / S = 2: With intermediate panel
 * : in designation, core, ref. replace by 1 or 2 depending on the type

→ Open slot bobbins - Output crimp terminals

b1	h1	b2	h2	k	k1	l1	l2	l3	Code S = 1	Code S = 2	Circuit	Ref.
51	51	98	110	25.5	21	69.5	74.5	80	A03203		EI 150/51	401
51	60	98	119	25.5	21	69.5	74.5	80	A03206	A03207	EI 150/60	402*
51	65	98	124	25.5	21	69.5	74.5	80	A03209		EI 150/65	403
51	70	98	129	25.5	21	69.5	74.5	80	A03212	A03213	EI 150/70	404*
51	81	98	140	25.5	21	69.5	74.5	80	A03215		EI 150/81	405
51	91	98	150	25.5	21	69.5	74.5	80	A03218		EI 150/91	405 B
51	101	98	160	25.5	21	69.5	74.5	80	A03221		EI 150/101	406
51	110	98	169	25.5	21	69.5	74.5	80	A03224		EI 150/110	407
61	41	119	111	34.5	25	84	89	99	A03303		EI 180/41	600
61	51	119	121	34.5	25	84	89	99	A03306		EI 180/51	600 B
61	61	119	131	34.5	25	84	89	99	A03309		EI 180/61	601
61	70	119	140	34.5	25	84	89	99	A03312		EI 180/70	602
61	75	119	145	34.5	25	84	89	99	A03315		EI 180/75	602 B
61	80	119	150	34.5	25	84	89	99	A03318		EI 180/80	603
61	90	119	160	34.5	25	84	89	99	A03321		EI 180/90	603 B
61	100	119	170	34.5	25	84	89	99	A03324		EI 180/100	604
61	110	119	180	34.5	25	84	89	99	A03327		EI 180/110	604 B
61	120	119	190	34.5	25	84	89	99	A03330		EI 180/120	605

ADDITIONAL PRODUCTS

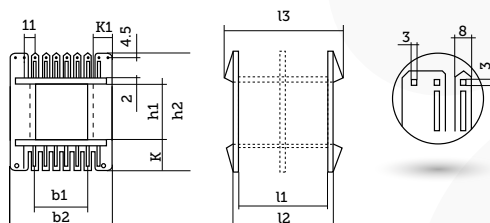
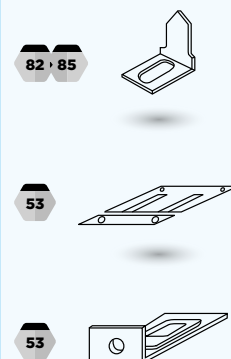

→ EI bobbins- Free wire outputs

A	C	F	G	SP	M	P	Code S=1	Code S=2	Circuit	Ref.
80	120	30	80	3	158	130	A05001		1/2 CAR. EI 240/30	MS30
80	120	40	90	3	158	130	A05003	A05021	1/2 CAR. EI 240/40	MS40
80	120	50	100	3	158	130	A05006	A05023	1/2 CAR. EI 240/50	MS50
80	120	60	110	3	158	130	A05008	A05024	1/2 CAR. EI 240/60	MS60
							A05026		50 MM EXTENSION	

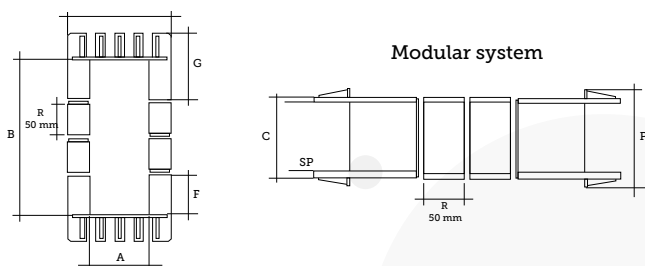

→ EI bobbins- Free wire outputs

A	C	F	G	SP	M	P	Code S=1	Core	Ref.
90.5	132	45	101	3.2	176	141.2		1/2 CAR. EI 270/45	SM45
90.5	132	55	111	3.2	176	141.2	A05041	1/2 CAR. EI 270/56	SM55
								30 MM EXTENSION	SPS30
								40 MM EXTENSION	SPS40

EI type lamination-based assemblies

BOBBINS

→ Bobbins - Presspahn

h1	b1	b2	h2	k	k1	Code	Ref.	Designation
81	41.5	137	158	44	38	A10051P	4700	EI 240/41
81	61	153	158	40	38	A10053P	4700A	EI 240/61
81	71	163	158	41	38	A10055P	4701	EI 240/71
81	81	178	158	43	38	A10057P	4702	EI 240/81
81	90	178	158	40	38	A10059P	4702A	EI 240/90
81	96	190	158	42	38	A10061P	4703	EI 240/96
81	100	190	158	40	38	A10063P	4703A	EI 240/100
81	110	203	158	41	38	A10065P	4703B	EI 240/110
81	121	211	158	41	38	A10067P	4704	EI 240/121

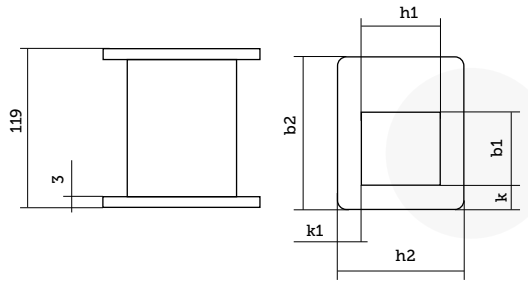

→ Standard "presspahn" bobbins for flat three-phase cores

	A	B	C	D	E	H	I	L	J	Code	
Cores 90x108	19	19	43	52	16.5	53	2	49	12	A10102P	19x19x53
	19	30	43	65	17.5	53	2	49	12	A10104P	19x30x53
	19	41	43	74	16.5	53	2	49	12	A10106P	19x41x53
Cores 105x126	22	22	52	60	19	62	2	58	15	A10108P	22x22x62
	22	26	52	67	20.5	62	2	58	15	A10110P	22x26x62
	22	31	52	77	20.5	62	2	58	19	A10112P	22x31x62
	22	40	50	80	20.5	62	2	58	14	A10114P	22x40x62
Cores 125x150	26	26	61	67	21	74	2	70	18	A10116P	26x26x74
	26	32	62	78	23	74	2	70	18	A10118P	26x32x74
	26	40	62	86	23	74	2	70	18	A10120P	26x40x74
	26	50	62	95	23	74	2	70	18	A10122P	26x50x74
	26	56	62	103	23.5	74	2	70	18.5	A10124P	26x56x74
	26	61.5	63	111	23.5	74	2	70	18.5	A10126P	26x61,5x74
	26	70	61	115	23	74	2	70	18	A10127P	26x70x74
Cores 150x180	31	31	73	77	23	89	3	83	21	A10128P	31x31x89
	31	40	74	108	34	89	3	83	21	A10130P	31x40x89
	31	45	73	111	33	89	3	83	21	A10132P	31x45x89
	31	50	74.5	118	34.5	89	3	83	21.5	A10134P	31x50x89
	31	60	76.5	130	34.5	89	3	83	22.5	A10136P	31x60x89
	31	70	73	140	34.5	89	3	83	21	A10138P	31x70x89
	31	80	74.5	148	34.5	89	3	83	21	A10140P	31x80x89
	31	90	75	156	33	89	3	83	22	A10142P	31x90x89
Cores 200x240	41	41	98.5	98	28.5	118	3	112	28.5	A10144P	41x41x118
	41	50	37.5	107	28.5	118	3	112	28.5	A10146P	41x50x118
	41	50	37.5	107	28.5	118	3	112	28.5	A10148P	41x60x118
	41	60	98.5	117	28.5	118	3	112	28.5	A10150P	41x71x118
	41	80	98.5	138	29.5	118	3	112	28.5	A10152P	41x80x118
	41	91	98	170	28.5	118	3	112	28.5	A10154P	41x91x118
	41	100	97.5	189	45.5	118	3	112	28.5	A10156P	41x100x118
	41	110	98.5	199	44.5	118	3	112	28.5	A10158P	41x112x118
	41	120	97.5	209	44.5	118	3	112	28.5	A10160P	41x120x118

ADDITIONAL PRODUCTS

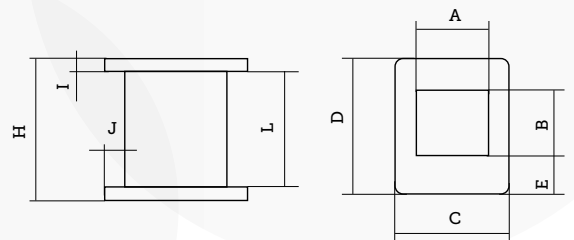
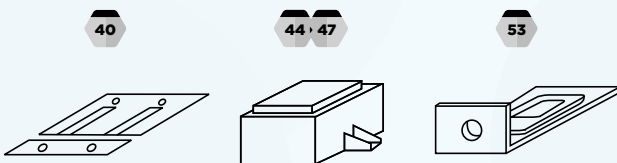

→ Straight ribbed bars for sheet metal mounting EI 42 to EI 240

A	B	C	D	E	N	F	G	H	Code	Ref.
35	7	28	3.5	0.9	0.9	1.8	7	3.7	C22420	EI- 42
37	7	30	4	0.9	0.9	1.8	8.5	3.5	C22300	EI- 44
40	8	32	4	0.9	0.9	1.8	8	3.7	C22430	EI- 48
44	8.5	35	4.35	0.9	0.85	1.8	9	3.4	C22310	EI- 52.5
45	9	36	4.5	0.9	0.9	1.8	9	3.7	C22440	EI- 54
50	10	40	5	0.9	0.92	1.8	12	4.8	C22320	EI- 60
55	11	44	5.5	0	1.2	1.8	13	4.8	C22450	EI- 66
62.5	12.5	50	6.25	0.9	1.2	1.8	14.9	4.8	C22330	EI- 75
65	13	52	6.5	1	1.2	2	13	4.8	C22460	EI- 78
70	14	56	7	1	1.2	2	16.4	4.8	C22340	EI- 84
80	16	64	8	1.2	1.45	2.4	16.8	5.8	C22350	EI- 96
87.5	17.5	70	8.75	1.2	1.4	2.4	17.5	5.7	C22355	EI- 105
90	18	72	9	1.2	1.45	2.4	21.2	5.8	C22360	EI- 108
100	20	80	10	1.2	2	2.4	23.6	5.8	C22365	EI- 120
105	21	84	10.5	1.2	1.7	2.4	24.6	6.8	C22370	EI- 126
125	25	100	12.5	1.5	2.15	3	29.4	8.6	C22380	EI- 150
145	29	116	14.5	3	2.6	6	29	10.7	C22385	EI- 174
150	30	120	15	3	4.75	6	36	9.5	C22386	EI- 180
175	35	140	17.5	3	5.25	6	41	10.5	C22387	EI- 210
200	40	160	20	3	6	6	47	12	C22390	EI-241-240



Also available in double thickness vertical/horizontal mounting versions.

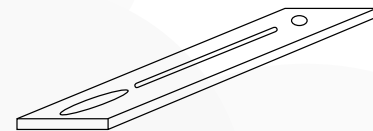
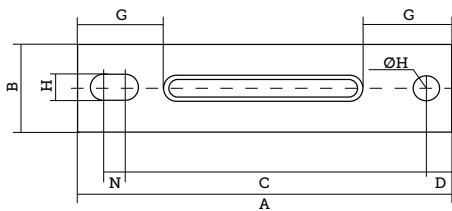

ZINC PLATED STEEL

→ Angle bars for ribbed/unribbed EI laminations

A	B	C	D	E	F	G	H/2	H	K	K1	L	N	Ribbed	Ref.	Unribbed Normal mounting	Unribbed Vertical mounting
51	10	40	5	0.9	1.8	12	1.85	3.7	17.7	20	12.1	0.92	C22515	EI-48		
56	11	44	5.5	0.9	1.8	13	2.4	4.8	22.3		15.1	1.2	C22500V1	EI-60		C22582
63.7	12	50	6.25	0.9	1.8	14.9	2.4	4.8	22.5	28	15.3	1.2	C22600V1	EI-66		
66.2	13	52	6.5	1	2	13	2.4	4.8	22.5		15.3	1.2	C22510V3	EI-75	C22583	
71.2	14	56	7	1.2	2.4	16.4	2.4	4.8	22.5	28	15.3	1.2	C22610V1	EI-78		
81.5	16	64	8	1.2	2.4	18.8	2.9	5.8	27.3	28	18.6	1.45	C22520V2	EI-84	C22585	C22586
89	17.5	70	8.75	1.2	2.4	17.5	2.85	5.7	28		19	1.4	C22530V2	EI-96	C22587	
91.6	18	72	9	1.2	2.4	21.2	2.9	5.8	28.3	30	19.6	1.45		EI-105		
101.8	20	80	10	1.2	2.4	23.6	2.9	5.8	32		21.2	2	C22540V1	EI-108		C22596
101.8	20	80	10	1.2	2.4	23.6	2.9	5.8	32		21.2	2	C22545V2	EI-120		
106.8	21	84	10.5	1.5	3	24.6	3.4	6.8	32.6	38	22.4	1.7	C22555	EI-126		C22593
127.5	25	100	12.5	2	4	29.4	4.3	8.6	41.6	35	28.7	2.15	C22560	EI-150	C22580V1	
153	30	120	15	3	6	36	4.75	9.5	44.7	40	30.5	4.75	C22562V1	EI-180	C22590	C22595
178	35	140	17.5	3	6	41	5.25	10.5	51		35.3	5.25	C22563	EI-210		
203	40	160	20	3	6	47	6	12	55.5		37.5	6	C22570V1	EI-240		

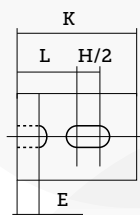
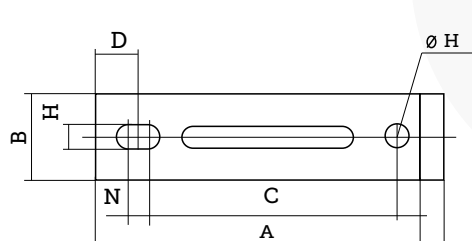

EI type lamination-based assemblies

EI FIXING ACCESSORIES

→ Straight clamps

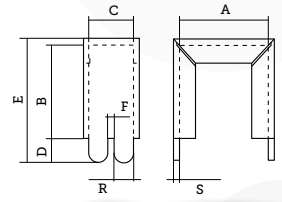

A	B	C	D	E	F	R	S	Code	Ref.
19.5	15.5	5.1	5	20.5	1 arm	2.8	30/100	C24210	275/19/5
19.5	15.5	7.4	6	22	2.8	2.1	6/10	C24220	275/19/7
32	27	9.2	8.5	36	3	3	6/10	C24250	275/32/9
32	26	13.2	8.5	34	3	5	6/10	C24270	275/32/13
32	26	14.5	8.5	34	3	5	6/10	C24290	275/32/14
38.4	32	15.5	8	40	0	6	6/10	C24214	275/38.4/15.5
44	36	17.2	8	44.5	0	4	6/10	C24216	275/44/17
v	27	10.5	8.5	36	3	3	6/10	C24218	275/32/10

Zinc plated steel

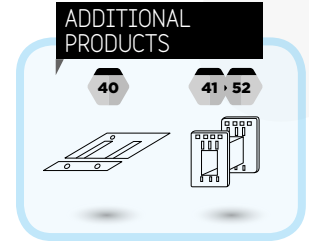

→ Folding clip shackles

A (+0.2/-0)	B (+0/-0.2)	C (+0.1/-0)	D	E	F	G	H	K	L	M	N	S	Code	Ref.
30	25	10.5	39	0.5	48	-	3.5	2.5	3.5	-	42	3	C24370	26/30/10
32	28	9.2	40	0.6	49	-	3.5	2.5	3.5	-	42	3	C24240V1	26/32/9
32	28	13.2	40	0.6	49	-	3.5	2.5	3.5	-	42	3	C24260	26/32/13
32	28	14.5	40	0.6	49	-	3.5	2.5	3.5	-	42	3	C24280V1	26/32/14
42	35	14.8	52	0.9	61	25	3.5	3.5	5	4.2	55	3	C24390	26/42/14
44	38	16.8	52	0.9	62	25	3.5	3.7	4.7	4.2	55	3	C24300	26/44/16
48	40	16.8	60	0.9	75.2	25	3.5	3.7	6	4.2	68.1	3	C24400	26/48/18
52.5	44	18	63	0.9	46.5	25	4.1	4	5	4.2	68.1	3	C24310	26/52.5/18
52.5	44	21.8	63	0.9	76.5	25	4.1	4	5	4.2	68.1	3	C24312	26/52.5/22
54	45	18.8	65	0.9	76	25	4.1	3.5	6.8	4.2	68	3	C24410	26/54/18
60	50	20.8	73	0.9	85	25	4.5	3.5	8	4.2	77	4	C24320	26/60/20
60	50	25.8	73	0.9	85	25	4.5	3.5	7.5	4.2	77	4	C24330	26/60/25
60	50	30	73	0.9	85	25	4.5	3.5	7.5	4.2	77	4	C24340	26/60/30
75	62.5	25.8	90	1	105	25	5.5	5.5	8.5	4.2	95	5	C24350	26/75/25
75	62.5	30	90	1	105	25	5.5	5.5	6.5	4.2	95	5	C24360	26/75/30

Zinc plated steel

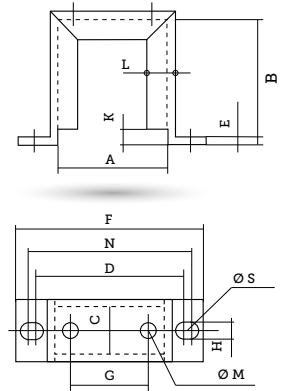

→ Series 97 circuit board mounts

A	B	C	D	E	F	G	M	Code	Ref.
35	7	28	3.5	1.2	8.7	16	M3	C22210	97-42
40	8	32	4	1.2	11.7	18	M3	C22220	97-48
45	9	36	4.5	1.2	11.7	21	M3	C22230	97-54
50	10	40	5	1.2	12.8	23	M3	C22240	97-60
55	11	44	5.5	1.2	14.5	25	M4	C22250	97-66
62.5	12	50	6.5	1.2	17.3	29	M4	C22280	97-75
65	12	52	6.5	1.2	16.5	30	M4	C22260	97-78
70	12	56	7		17	35	M4	C22270	97-84

Zinc plated steel

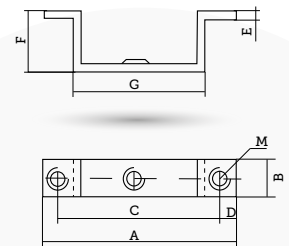

→ Corner clips

A1	A	B	C	C1	D	D1	E	F	G	G1	H	Code Type 1	Code Type 2	Ref. Type 1	Ref. Type 2
60.5		60.5	12.5		24		5	5	1		50	C22110		300-60	
75	61	75	15.5	15.5	22.5	22.5	6.5	5	1	1	62.5	C22120	C22700	300-75	311-75
84	70	84	17.5	17.5	21	21	7	5	1	1	70	C22130	C22702	300-84	311-84
96	82	96	18	17.5	23.5	24	8	6	1	1	80	C22140	C22704	300-96	311-96
108	94	108	21.5	21.5	25	25	9	6	1	1	90	C22150	C22706	300-108	311-108
126	112	126	25	25	26.5	26.5	10.5	7	1	1.2	105	C22160	C22708	300-126	311-126
150	136	150	28.5	28.5	26.5	26.5	12	9.5	1	1.2	125	C22170	C22709	300-150	311-150
180	166	180	35	35	30	30	15	9.5	1	1.5	150	C22180	C22710	300-180	311-180
196		210	40		40		17.5	10.5	3		175				311-210
226		240	40		40	20	20	12	3		200		C22712		311-240

Zinc plated steel

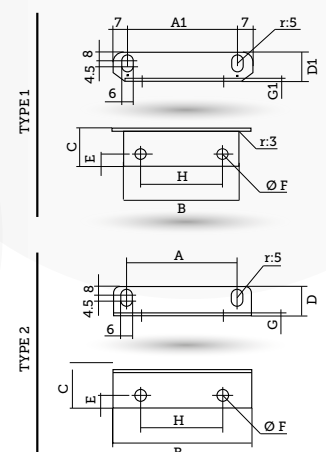

→ Protective covers without legs EI 60 to EI 180 cores

A	B	C	D	E	P	Code	Ref.
60	50	50	40	4	24	C24010	29-60
75	62.5	62.5	50	4.5	27	C24020	29-75
84	70	70	56	5.5	35	C24030	29-84
96	80	80	64	6	36	C24040	29-96
108	90	90	72	6	38	C24050	29-108
126	105	105	84	6.5	43	C24060	29-126
150	125	125	100	9	50	C24070	29-150
180	150	150	120	9	54	C24080	29-180

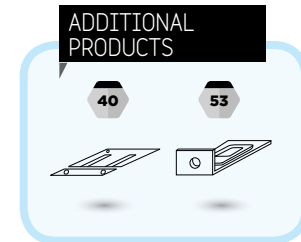
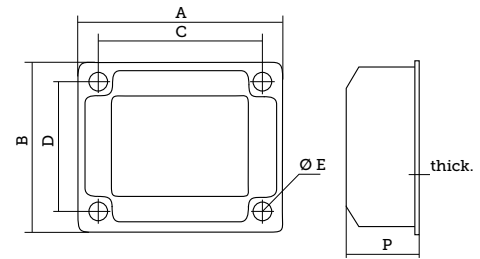

Zinc plated steel (untreated upon request).

→ Protective covers with legs EI 60 to EI 150 cores

G	H	I	J	K	L	B	Code	Ref.
8	76	60	43	15.5	4.5	57	C24110	31-60
10	89.5	75	55	16.5	5	69.5	C24120	31-75
9	98.5	84	60	18.5	5.5	74	C24130	31-84
10	111	96	72	17.5	6	87	C24140	31-96
10	120	106	82	21	6	95	C24150	31-108
12	141	126	101	22	6	110	C24160	31-126
12	167	150	122	25	7	128	C24170	31-150

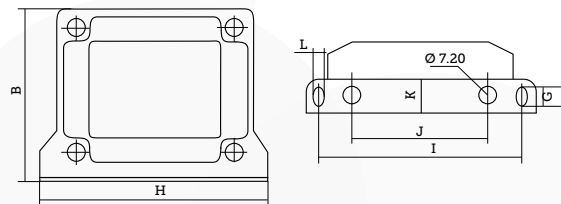

Zinc plated steel (untreated on request).
Other dimensions above.

→ Protective cover fixing corners PM and GM

A	B	C	D	E	F	G	Code	Ref.
17	14	10.5	10.5	8	4.2	1.5	C24180	270 PM EI 60 to EI 96
21.8	19.5	12.5	15	10	5.3	1.2	C24190	270 GM EI 108 to EI 150

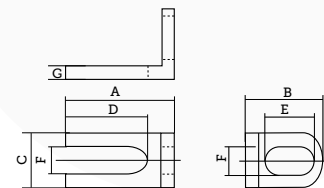

→ Distribution plates EI 60 to EI 240 for mounting frames without holes

Type	C	B	A	Code 1	Code 2
EI 60	60	15	2	A25110	A25210
EI 75	75	15	1.6	A25120	A25220
EI 84	84	20	1.6	A25130	A25230
EI 96	96	20	2	A25140	A25240
EI 108	108	25	3	A25150	A25250
EI 126	126	30	4	A25160	A25260
EI 150	150	30	4	A25170	A25270
EI 180	180	35	4	A25180	A25280
EI 240	240	35	4	A25190	A25290

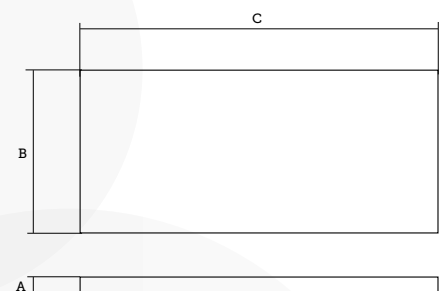

"Code 1" : Bakelite fabric
"Code 2" : Polyester

Plate with optional hole (285 series)

EI type lamination-based assemblies

EI FIXING ACCESSORIES

→ Mounting frames for three-phase cores EI 108 to EI 240

Type	A	B	C	D	E	F	G	H	I	L	P	Ød	Ød1	e	Code	Core
EI 108	140	100	21.5	90	30	85	5.5	110	12.5	12.5	6	6.5	4.5	1.5	C23410	90x108 TRI
EI 126	162	120	26	105	30	100	5.5	129	12.5	12.5	6	7	4.5	1.5	C23420	105x126 TRI
EI 150	195	140	30	125	30	120	5.5	160	12.5	12.5	6	9.5	4.5	1.5	C23430	125x150 TRI
EI 180	235	159	32.5	150	35	175	7.5	200	13.5	15.5	7	9.5	4.5	2.0	C23440	150x180 TRI
EI 240	310	210	43	200	40	220	10	280	15	20	9	12	5	2.0	C23450	200x240 TRI

Sold in pairs without insulation - identical frames
Zinc plated steel.

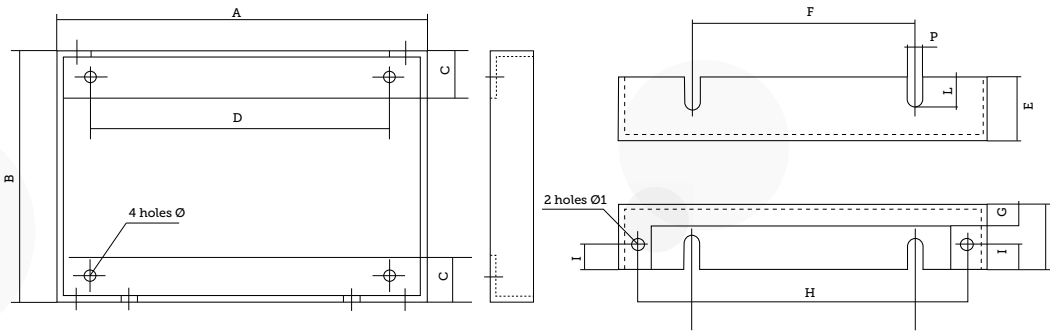

ADDITIONAL PRODUCTS

41 · 52

40

82 · 85

→ Mounting support EI type series 280

A	B	ep	C1	C2	C3	D1	D2	D3	D4	d	E1	E2	E3	E4	Code	Ref.
50	60	1.2	17.8	6	10	5	41.8	40	30	4.5	12.2	6.7	5	20	C23310	280-60
62.5	75	1.5	22.5	6	12.5	6.25	52.4	50	41	4.8	15.3	8.1	6.3	28	C23320	280-75
70	84	1.5	23	7	14	7	58.4	56	65	4.8	15.3	8.1	7	30	C23330	280-84
80	96	2	27	7	16	8	67	64	75	5.8	18.5	9.8	8	38	C23340	280-96
90	108	2	28.5	8	18	9	75	72	82	5.8	19.5	10.8	8.5	45	C23350	280-108
105	126	2	32.5	10	21	10.5	87.4	84	100	6.8	22.4	12.2	10.2	56	C23360	280-126
125	150	2	41.5	9	25	12.5	104.3	100	118	8.6	28.7	15.8	12	66	C23370	280-150
150	180	2	45	12	30	15	124.8	120	142	9.5	30.5	16.3	15	86	C23380	280-180
200	240	2	56	15	40	20	166	160	196	12	38	20	20	126	C23390	280-240

These frames are sold individually without insulation and without any screws.
Zinc plated steel

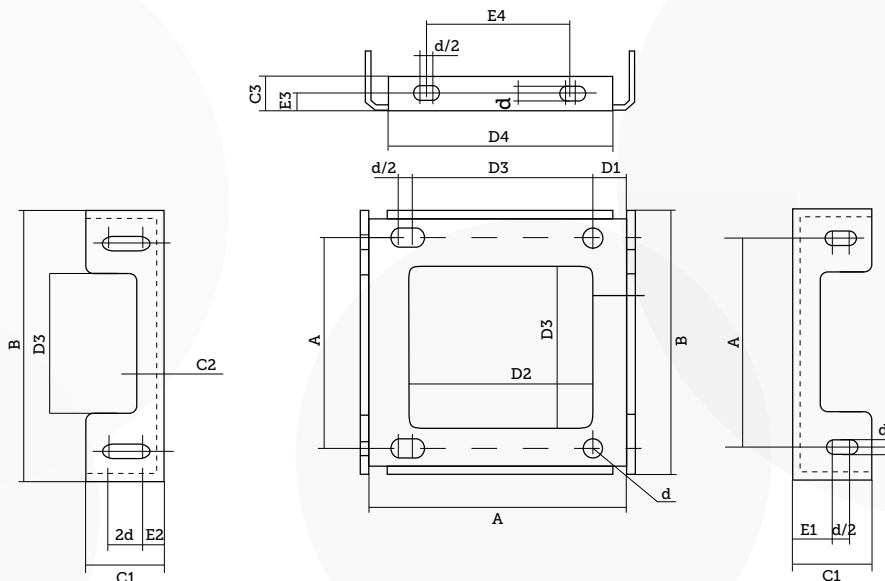

→ Corner clips series 58

A	B	E	F	G	C	I	P	NxM	e1	Type	Code	Ref.
72.5	62.5	50	5	9	7	4.5	7	4x7.5	1.5	1	C22800	58.75V
80	70	56	5	9	7	4.5	7	4x7.5	1.5	1	C22802	58.84V
90	80	65	5	11.5	7	5.5	7	5x8	1.5	1	C22804	58.96V
90	76	72	5	11	20.5	5	13	5x9	1.5	2	C22806	58108V
105	89	85	6	12	21	6	13	5x10	1.5	2	C22808	58126V
125	100	100	12	14.5	25	9	15	6.5	2	2	C22810	58150V
85	75	62.5	5	9	7	4.5	7	4x7.5	1.5	1	C22900	58.75
94	84	70	5	9	7	4.5	7	4x7.5	1.5	1	C22902	58.84
105	95	80	5	11.5	7	5.5	7	5x8	1.5	1	C22904	58.96
108	94	90	5	11	22	5	13	5x9	1.5	2	C22906	58108
126	110	105	6	12	21	6	13	5x10	1.5	2	C22908	58126
150	125	125	12	14.5	25	9	15	6.5	2	2	C22910	58150

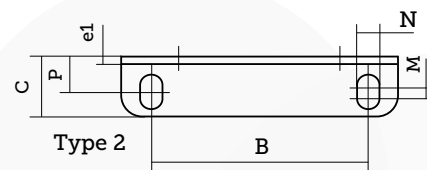
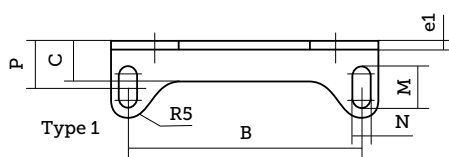
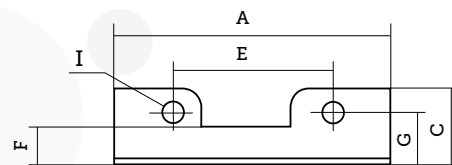
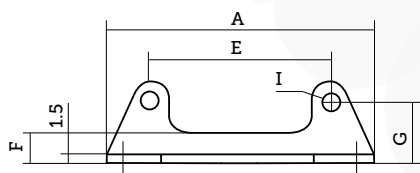

EI type lamination-based assemblies

BOXES FOR EI LAMINATION

→ Mounting support for EI core Series 60

A	B	C	D	E	F	G	H	I	J	K	L	M	N	O	P	Q	R	Code	Ref.
80	96	92	35	65	5	14.5	80	6	64	25	10	8	10	12.5	55	35	5	C24500	60x96
90	108	104	46	73	6	16	90	7	72	30	12	9	11	14	62	35	5.5	C24502	60x108
105	126	119	45	85	7	18.5	105	7	84	30	12	10.5	12.5	16.5	72	35	5.5	C24504	60x126
127.5	150	139	45	101	9	20.5	125	7	100	30	12	12.5	14.5	18.5	88	35	5.5	C24506	60x150
150	180	166	50	121	9	25	150	9	120	35	14	15	17	23	104	35	6.5	C24508	60x180

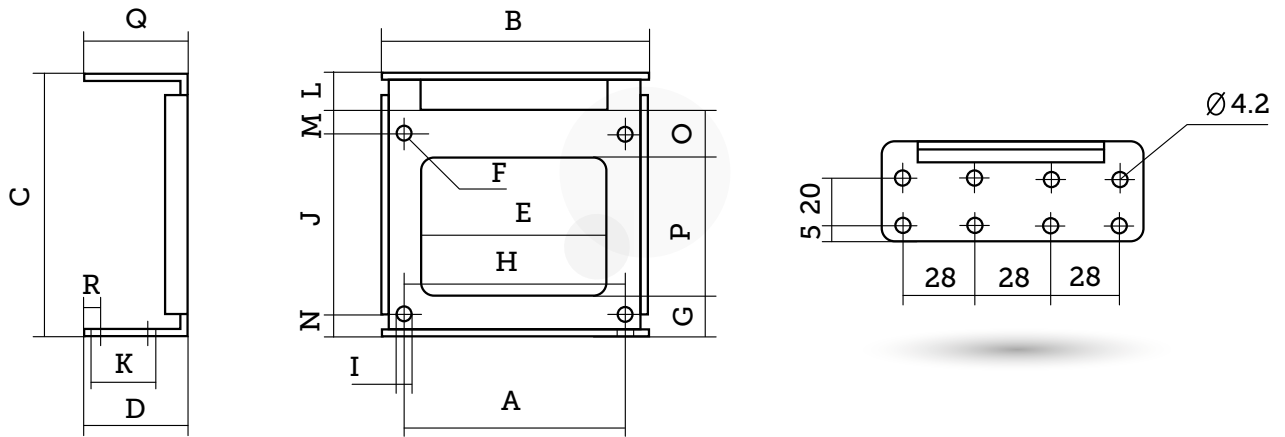

→ Low version - Fimo type 60 B series

U	V	W	Code	Ref.
69.6	60	82	C24510	60.96 B
73	64	92	C24512	60.108 B
101	92	127	C24516	60.150 B
121	112	152	C24518	60.180 B
85	76	107	C24514	60.126 B

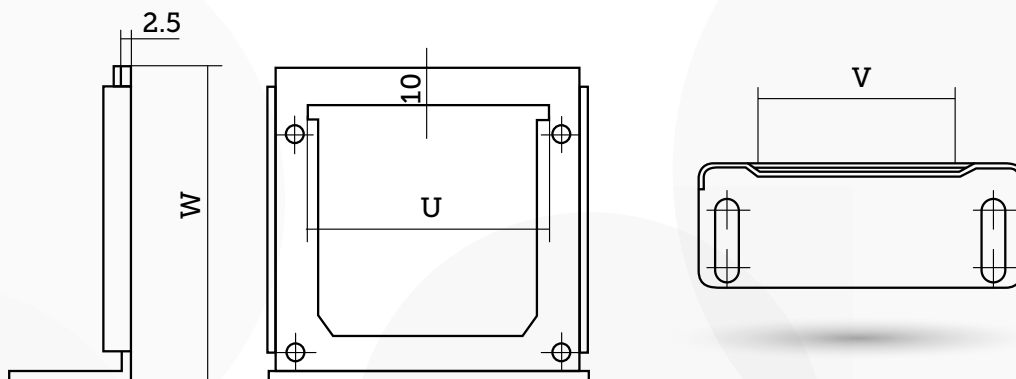



UI-M-EE type lamination- based assemblies

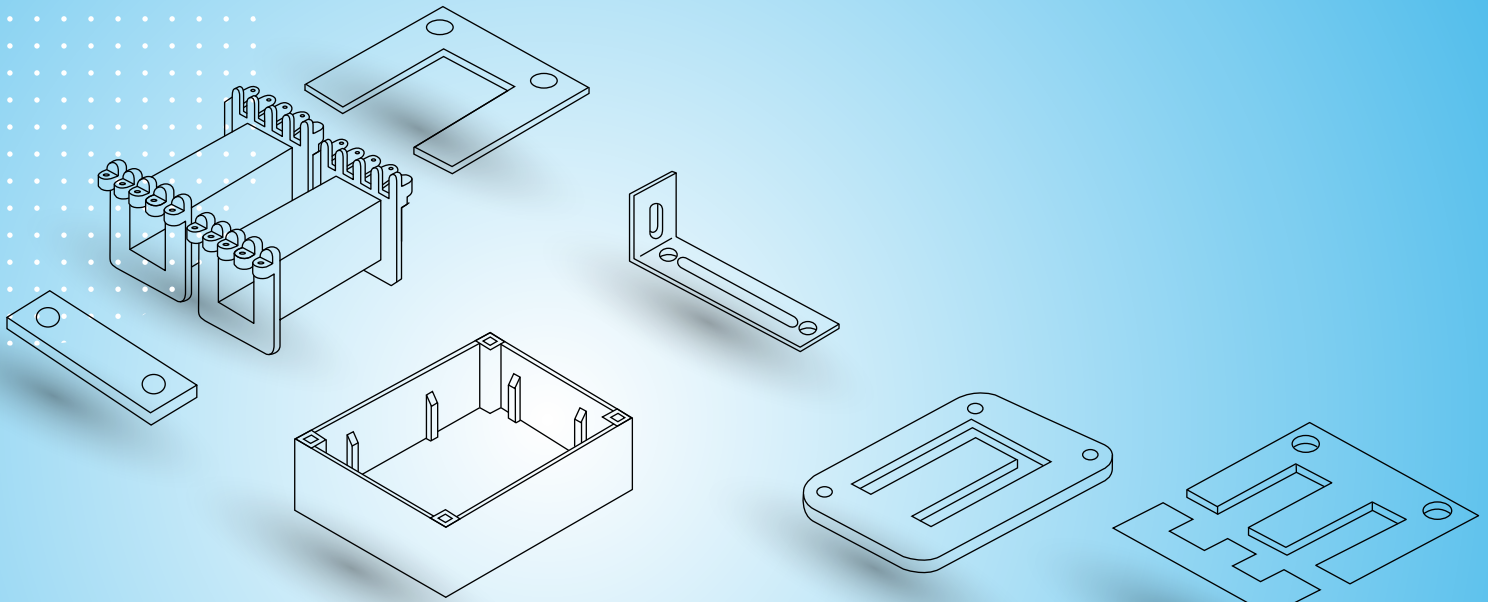

UI-M-EE type lamination-based assemblies

UI LAMINATIONS AND EE LAMINATIONS

→ UI lamination DIN Standard 41302

Core	a	b	c	Ød	g	f	Kg% 50/100	Kg% 35/100	Code 0w6	Code 1w3
UI 30	30	40	10	3.5	20	35	4.47	3.11	C15255	C15205
UI 39	39	52	13	3.5	26	45.5	7.66	5.33	C15256	C15206
UI 48	48	64	16	4.5	32	56	11.58	8.05	C15257	C15207
UI 60	60	80	20	4.5	40	70	18.23	12.68	C15258	C15208
UI 75	75	100	25	5.5	50	87.5	28.51	19.83	C15259	C15209
UI 90	90	120	30	7.8	60	105	40.84	28.4	C15260	C15210
UI 102	102	136	34	7.8	68	119	52.67	36.63	C15261	C15211
UI 114	114	152	38	11	76	133	65.25	45.38	C15262	C15212
UI 120	120	160	40	11	80	140	72.46	50.39		
UI 132	132	176	44	11	88	154	87.98	61.18	C15263	C15213
UI 144	144	192	48	11	96	168	106.1	73.78		
UI 150	150	200	50	11	100	175	114.04	79.31	C15264	C15214
UI 168	168	224	56	11	112	196	143.42	99.74	C15265	C15215
UI 180	180	240	60	11	120	210	164.86	114.65	C15266	C15216
UI 210	210	280	70	15	140	245	223.66	155.54	C15267	C15217
UI 240	240	320	80	15	160	280	292.96	203.74	C15268	C15218

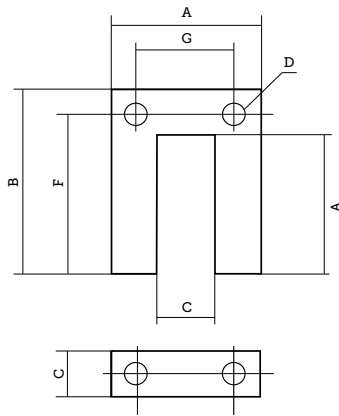

ADDITIONAL PRODUCTS

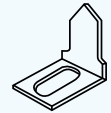
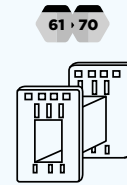

→ EE lamination DIN Standard 41302

Type	a x b	A	B1	B2	E1	E2	F	G	Kg% 0.5	Kg% 0.35	Code 0w6	Code 1w3
EE 20	20x14	20	14	6	11	3	6	14	1.11	0.77	C15615	C15605
EE 25	25x17	25	17	8	13.2	4.2	7.6	17.4	1.75	1.21	C15616	C15606
EE 10	10x7	10	7	3	5.5	1.5	3	7				

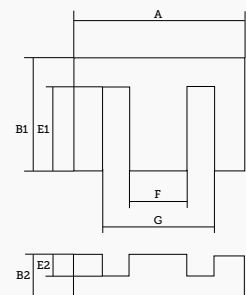

EQUIVALENCE TABLE FOR BOBBINS

For three phase core lamination	50 x 50	= UI 30 bobbins	= SU 30	= S3U 30
For three phase core lamination	65 x 65	= UI 39 bobbins	= SU 39	= S3U 39
For three phase core lamination	80 x 80	= UI 48 bobbins	= SU 48	= S3U 48
For three phase core lamination	100 x 100	= UI 60 bobbins	= SU 60	= S3U 60
For three phase core lamination	125 x 125	= UI 75 bobbins	= SU 75	= S3U 75
For three phase core lamination	150 x 150	= UI 90 bobbins	= SU 90	= S3U 90
For three phase core lamination	170 x 170	= UI 102 bobbins	= SU 102	= S3U 102
For three phase core lamination	190 x 190	= UI 114 bobbins	= SU 114	= S3U 114
For three phase core lamination	200x 200	= UI 120 bobbins	= SU 120	= S3U 120
For three phase core lamination	220 x 220	= UI 132 bobbins	= SU 132	= S3U 132
For three phase core lamination	250 x 250	= UI 150 bobbins	= SU 150	= S3U 150



Our partner **Weisser** proposes an extensive range of products for UI mounting.

We encourage you to consult the **www.weisser.de** website or pages 11 to 21 and 109 to 157 of the Weisser Catalogue in order to access the entire range.

OD (DIN 41 305)
M 42 - M 102

PAGE
11
Weisser
Catalogue

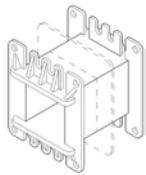

LP (DIN 41 305)
M 42 - M 102

PAGE
12
Weisser
Catalogue

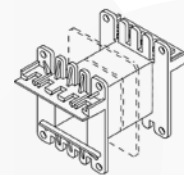

ST
with pins especially for E-ferrites
E-30

PAGE
13
Weisser
Catalogue

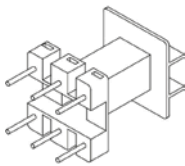

ST
with pins especially for
E-ferrites
E-30

PAGE
13
Weisser
Catalogue

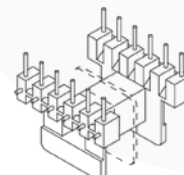

ST
with pins
M 30

PAGE
13
Weisser
Catalogue

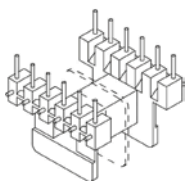

ST
M 42 - M 55

PAGE
14
Weisser
Catalogue

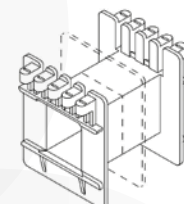

UI-M-EE type lamination-based assemblies

VARIOUS PRODUCTS FOR UI-M-EE MOUNTING

ST
M 42

PAGES
14
15
Weisser
Catalogue

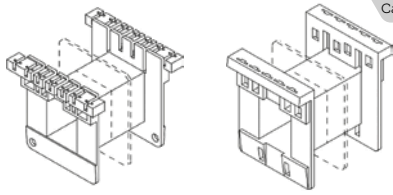

ST
E 70

PAGE
15
Weisser
Catalogue

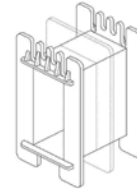

ST
M 55 - M 102

PAGE
16
Weisser
Catalogue

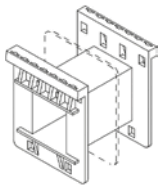

ST
M 74

PAGE
16
Weisser
Catalogue

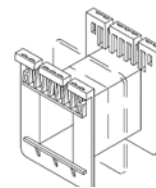

ST/II-HD
with shrouds for wire
protection
M 42 - M 55

PAGE
17
Weisser
Catalogue

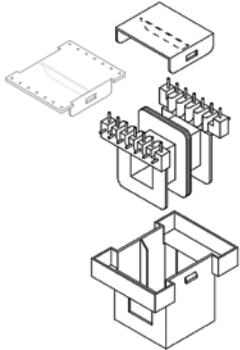

ST/II-HD
with shrouds for terminal
protection
M 42 - M 55

PAGE
18
Weisser
Catalogue

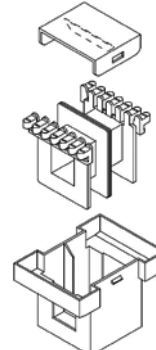

LP/II-HD
M 55 - M 102

PAGE
19
Weisser
Catalogue

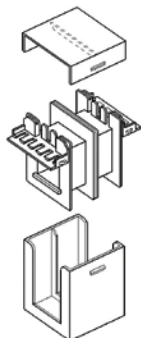

"O" TYPE BOX
E 30 - M 30 - M 42

PAGE
20
Weisser
Catalogue

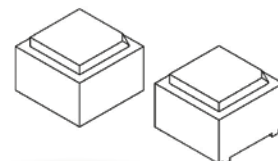

"O" TYPE BOX
E 30 - M 30 - M 42

PAGES
20
21
Weisser
Catalogue

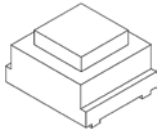

"K" TYPE BOX
with moulded-in pins
M 30 - M 42

PAGE
21
Weisser
Catalogue

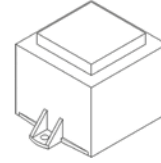

"KK" TYPE BOX
with moulded-in pins
M 455 - M 74 - MD 65

PAGE
21
Weisser
Catalogue

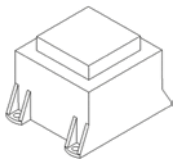

EQUIVALENT TO DIN 41
305 (obsolete)
UI 30 - UI 48

PAGE
109
Weisser
Catalogue

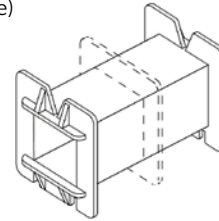

OD (DIN 41 305)
UI 60 - UI 180

PAGES
110
111
Weisser
Catalogue

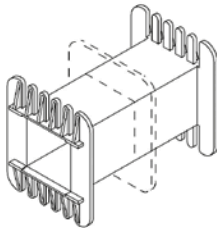

OD
with fixing ribs
UI 60 - UI 180

PAGES
111
112
Weisser
Catalogue

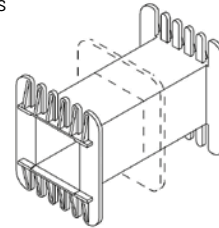

OD
with cut-outs
UI 60 - UI 180

PAGE
113
Weisser
Catalogue

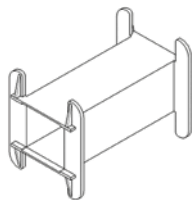

OD-UL
UI 60 - UI 180

PAGE
114
Weisser
Catalogue

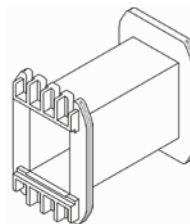

MS-UL
with mounting rails
EI 39 - UI 150

PAGE
115
Weisser
Catalogue

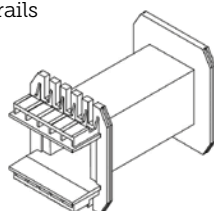

LP (DIN 41 305)
UI 60 - UI 90

PAGE
116
Weisser
Catalogue

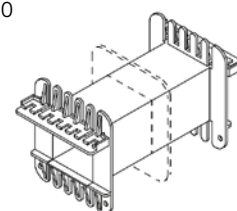

UI-M-EE type lamination-based assemblies

VARIOUS PRODUCTS FOR UI-M-EE MOUNTING

ST
with dovetail connection
UI 39 - UI 60

PAGES
116
117
Weisser
Catalogue

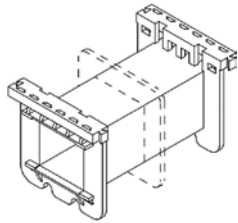
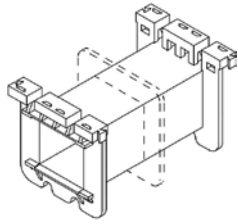

ST
for fixing ribs
UI 39 - UI 60

PAGE
118
Weisser
Catalogue

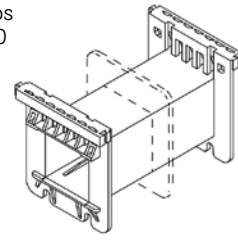

ST
for terminals
UI 48

PAGE
118
Weisser
Catalogue

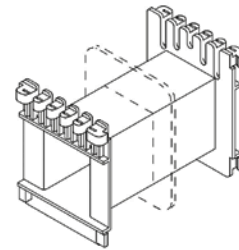

ST/II-HD
UI 39

PAGE
119
Weisser
Catalogue

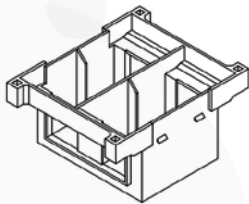
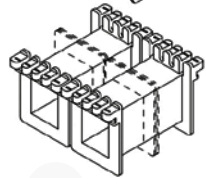
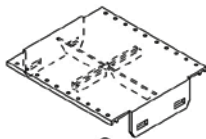

INFO:
Explanation:
Bobbins for 3-phase
laminations

PAGE
120
Weisser
Catalogue

BOX
UI 39 - 3UI 39

PAGE
121
Weisser
Catalogue

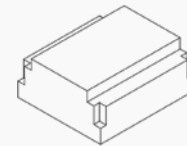

BOX
UI 48 - 3UI 48

PAGE
121
Weisser
Catalogue

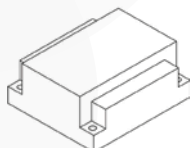

BOX
UI 48

PAGE
121
Weisser
Catalogue

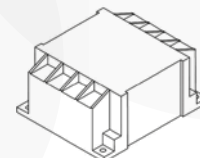

LOW PROFILE
VERSION

with moulded-in pins
U 21

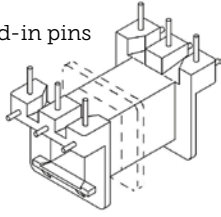

PAGE
125
Weisser
Catalogue

LOW PROFILE BOX
"O" TYPE

U 21

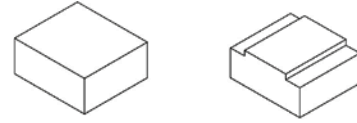

PAGE
125
Weisser
Catalogue

LOW PROFILE
VERSION

with pins
UI 30 - UI 39

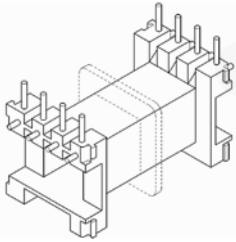

PAGES
125
126
Weisser
Catalogue

LOW PROFILE
VERSION

with pins
UI 30 - UI 39

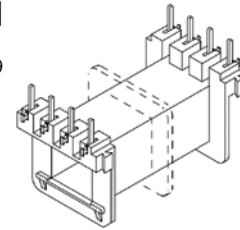

PAGES
126
127
Weisser
Catalogue

LOW PROFILE BOX
"VE" TYPE

UI 30 UI 39

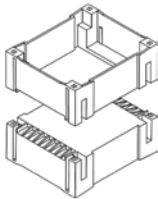

PAGES
128
130
Weisser
Catalogue

LOW PROFILE BOX

UI 30 - UI 38

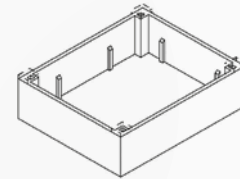

PAGES
129
131
Weisser
Catalogue

BASE PLATES AND
ACCESSORIES

PAGES
132
133
Weisser
Catalogue

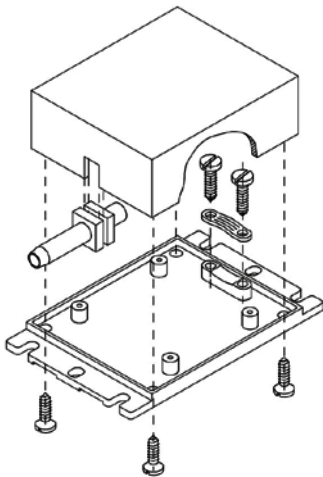

UI-M-EE type lamination-based assemblies

VARIOUS PRODUCTS FOR UI-M-EE MOUNTING

ST

vertical with moulded-in pins and increased creepage distances
EE 10

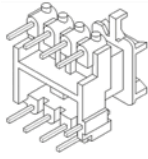

PAGE

137

Weisser Catalogue

ST

vertical with moulded-in pins and increased creepage distances
EE 16

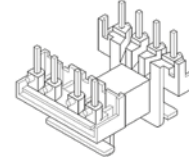

PAGE

137

Weisser Catalogue

ST

vertical with moulded-in pins and increased creepage distances
EE 20 - EE 25

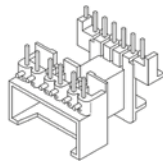

PAGE

137

Weisser Catalogue

ST

vertical with pins
EE 12.6 - EE 16 - EE 20
EE 25 - EE 32

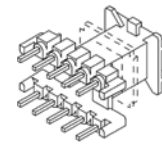

PAGES

138

141

Weisser Catalogue

INFO:

Explanation:
Bobbins for SMD-technology

PAGE

142

Weisser Catalogue

ST

with moulded-in pins
EE 12.6

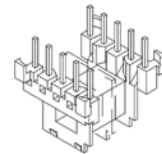

PAGE

143

Weisser Catalogue

ST

with moulded-in pins
& pick & place cap
EE 12.6 - EE20

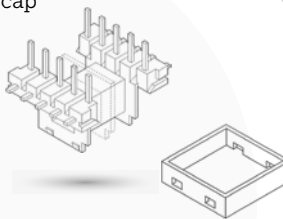

PAGES

143

147

Weisser Catalogue

ST

with moulded-in pins
EE 16 - EE 20 - EE 25
EE 32 - EE 40

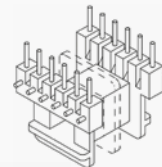

PAGES

143

147

Weisser Catalogue

ST

with moulded-in pins
EE16

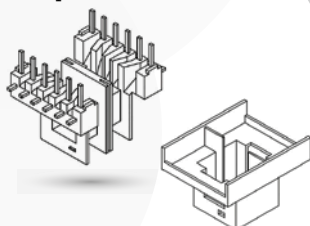

PAGE

145

Weisser Catalogue

ST

with moulded-in pins
EE16

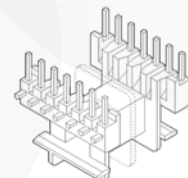

PAGES

144

145

Weisser Catalogue

ST
with pins
EE 20

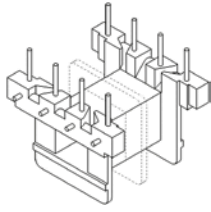

PAGES
145
146
Weisser
Catalogue

ST
with pins
EE 25 - EE 32
EE 40

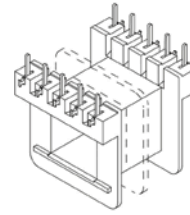

PAGE
148
Weisser
Catalogue

ST
with pins
EE 25

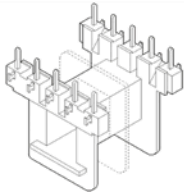

PAGE
148
Weisser
Catalogue

ST
with moulded-in pins
EV 15

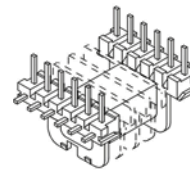

PAGE
149
Weisser
Catalogue

"O" TYPE VERTICAL BOX
EE 12.6 - EE 16 - EE 20
EE 25 - EE 32

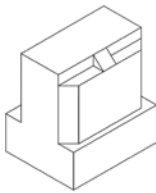

PAGES
150
151
Weisser
Catalogue

"O" TYPE BOX
EE 12.6

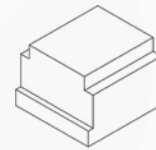

PAGE
151
Weisser
Catalogue

"O" TYPE BOX
EE 16 - EE 20

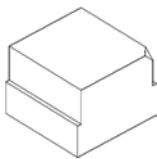

PAGES
152
154
Weisser
Catalogue

"O" TYPE BOX
EE 20 - EE 25
EE 32 - EE 40

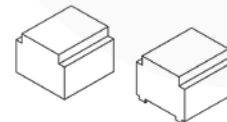

PAGES
153
157
Weisser
Catalogue

UI-M-EE type lamination-based assemblies

VARIOUS PRODUCTS FOR UI-M-EE MOUNTING

"O" TYPE BOX
EE 20 - E 25
ED 25

PAGES
154
155
Weisser
Catalogue

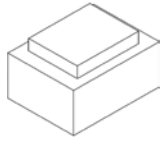

"O" TYPE BOX
EE 12.6 - EE 16
EE 20 - ED 12.6
ED 16

PAGES
152
154
Weisser
Catalogue

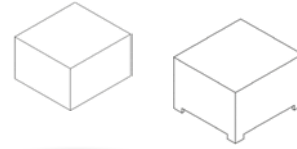

"O" TYPE BOX
EE 25L - EE 32L

PAGE
156
Weisser
Catalogue

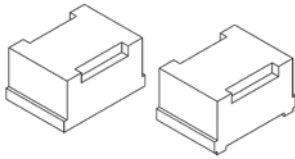

BOX
with fixings
"K" type
EE 40

PAGE
157
Weisser
Catalogue

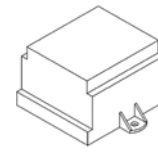

→ Half bobbins UI 180

1 bobbin is made up of 2 half-bobbins and 2 dividers

a	b	c	f	g	sp	m	n	p	Code	Core	Ref.
									A05223	1/2 Ui 180 bobbin in pa6 half bobbin	1333
61	60	180	30	64	2	118	128	189	A05230	Divider for UI 180/60 pa6 bobbin	1500
61	70	180	30	64	2	118	138	189	A05231	Divider for UI 180/70 pa6 bobbin	1501
61	80	180	30	64	2	118	148	189	A05232	Divider for UI 180/80 pa6 bobbin	1502
61	90	180	30	64	2	118	158	189	A05233	Divider for UI 180/90 pa6 bobbin	1503
61	100	180	30	64	2	118	168	189	A05234	Divider for UI 180/100 pa6 bobbin	1504
61	110	180	30	64	2	118	178	189	A05235	Divider for UI 180/110 pa6 bobbin	1505
61	120	180	30	64	2	118	188	189	A05236	Divider for UI 180/120 pa6 bobbin	1506
61	130	180	30	64	2	118	198	189	A05237	Divider for UI 180/130 pa6 bobbin	1507

→ Half bobbins UI 210

1 bobbin is made up of 2 half-bobbins and 2 dividers

a	b	c	f	g	sp	m	n	p	Code	Core	Ref.
									A05224	1/2 Ui 210 bobbin in pa6 half bobbin	H5000
71	70	210	35	81	3	139	162	221	A05214	Divider for UI 210/70 pa6 bobbin	1600
71	80	210	35	81	3	139	172	221	A05215	Divider for UI 210/80 pa6 bobbin	1601
71	90	210	35	81	3	139	182	221	A05216	Divider for UI 210/90 pa6 bobbin	1602
71	100	210	35	81	3	139	192	221	A05217	Divider for UI 210/100 pa6 bobbin	1603
71	110	210	35	81	3	139	202	221	A05218	Divider for UI 210/110 pa6 bobbin	1604
71	120	210	35	81	3	139	212	221	A05219	Divider for UI 210/120 pa6 bobbin	1605
71	130	210	35	81	3	139	222	221	A05220	Divider for car UI 210/130 pa6	1606
71	140	210	35	81	3	139	232	221	A05221	Divider for UI 210/140 pa6 bobbin	1607

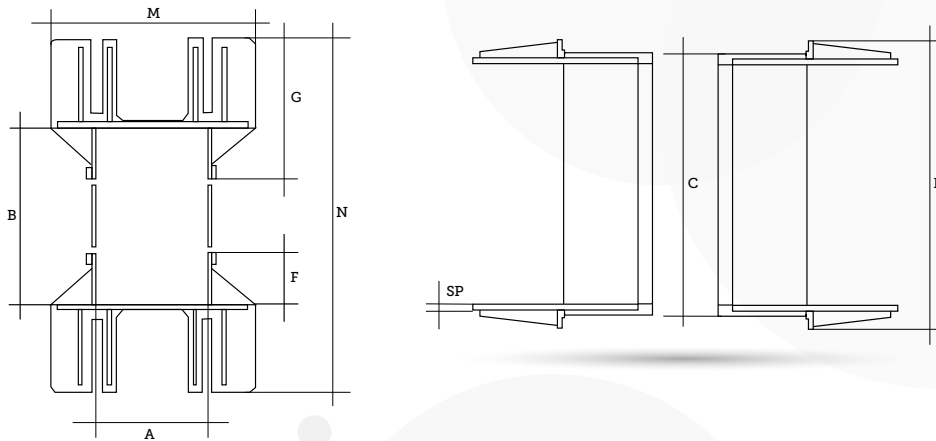

→ Bobbins UI 210

a	b	c	sp	m	n	p	Code	Core	Ref.
70	70	210	3	139	162	221	A05225	UI 210/70 bobbin	3000
70	80	210	3	139	172	221	A05226	UI 210/80 bobbin	3001
70	90	210	3	139	193	221	A05227	UI 210/90 bobbin	3002
70	100	210	3	139	193	221	A05228	UI 210/100 bobbin	3003

UI-M-EE type lamination-based assemblies

OPEN SLOT BOBBINS

→ Half bobbins UI 240

a	b	c	f	g	sp	m	n	Code	Core	Ref.
								A05610	1/2 Ui 240 bobbin in CH type half bobbin	5050CH
								A05610AM	1/2 Ui 240 bobbin in AP type half bobbin	5050AP
81.5	80	240	40	100	3	160	200	A05620	Divider for UI 240/80 CH type bobbin	1337CH
81.5	80	240	40	100	3	160	200	A05620AM	Divider for UI 240/80 AP type bobbin	1337AP
81.5	90	240	40	100	3	160	210	A05621	Divider for UI 240/90 CH type bobbin	1338CH
81.5	90	240	40	100	3	160	210	A05621AM	Divider for UI 240/90 AP type bobbin	1338AP
81.5	100	240	40	100	3	160	220	A05622	Divider for UI 240/100 CH type bobbin	1339CH
81.5	100	240	40	100	3	160	220	A05622AM	Divider for UI 240/100 AP type bobbin	1339AP
81.5	110	240	40	100	3	160	230	A05623	Divider for UI 240/110 CH type bobbin	1340CH
81.5	110	240	40	100	3	160	230	A05623AM	Divider for UI 240/110 AP type bobbin	1340AP
81.5	120	240	40	100	3	160	240	A05624	Divider for UI 240/120 CH type bobbin	1341CH
81.5	120	240	40	100	3	160	240	A05624AM	Divider for UI 240/120 AP type bobbin	1341AP
81.5	130	240	40	100	3	160	250	A05625	Divider for UI 240/130 CH type bobbin	1342CH
81.5	130	240	40	100	3	160	250	A05625AM	Divider for UI 240/130 AP type bobbin	1342AP
81.5	140	240	40	100	3	160	260	A05626	Divider for UI 240/140 CH type bobbin	1343CH
81.5	140	240	40	100	3	160	260	A05626AM	Divider for UI 240/140 AP type bobbin	1343AP
81.5	150	240	40	100	3	160	270	A05627	Divider for UI 240/150 CH type bobbin	1344CH
81.5	150	240	40	100	3	160	270	A05627AM	Divider for UI 240/150 AP type bobbin	1344AP

CH = insulating panel
AP = heat dissipation system

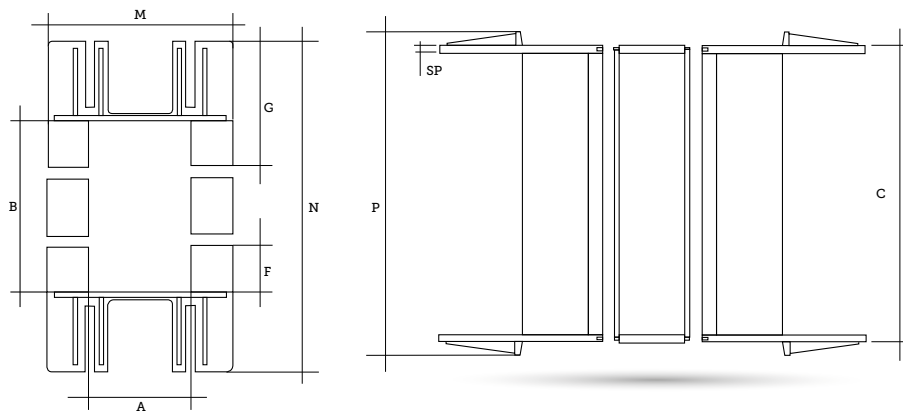

→ Half bobbins UI 300

a	b	c	f	g	z	r	sp	m	n	ρ	Code	Core	Ref.
											A05608	1/2 Ui 300 bobbin in PA6 half bobbin	8000
100	80	300	40.3	130.8	46.5	6.5	46.5	199	261.6	328		Divider for UI 300/80 bobbin	8001
100	90	300	40.3	130.8	46.5	6.5	46.5	199	271.6	328		Divider for UI 300/90 bobbin	8002
100	100	300	40.3	130.8	46.5	6.5	46.5	199	281.6	328	A05630V1	Divider for UI 300/100 bobbin	8003
100	110	300	40.3	130.8	46.5	6.5	46.5	199	291.6	328	A05631	Divider for UI 300/110 bobbin	8004
100	120	300	40.3	130.8	46.5	6.5	46.5	199	301.6	328	A05632	Divider for UI 300/120 bobbin	8005
100	130	300	40.3	130.8	46.5	6.5	46.5	199	311.6	328	A05633	Divider for UI 300/130 bobbin	8006
100	140	300	40.3	130.8	46.5	6.5	46.5	199	321.6	328	A05634	Divider for UI 300/140 bobbin	8007
100	150	300	40.3	130.8	46.5	6.5	46.5	199	331.6	328	A05635	Divider for UI 300/150 bobbin	8008
100	160	300	40.3	130.8	46.5	6.5	46.5	199	341.6	328	A05636	Divider for UI 300/160 bobbin	8009

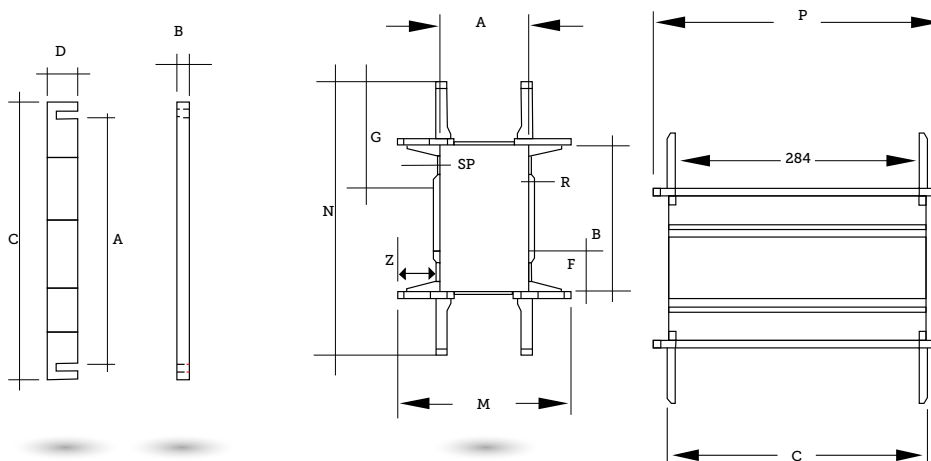

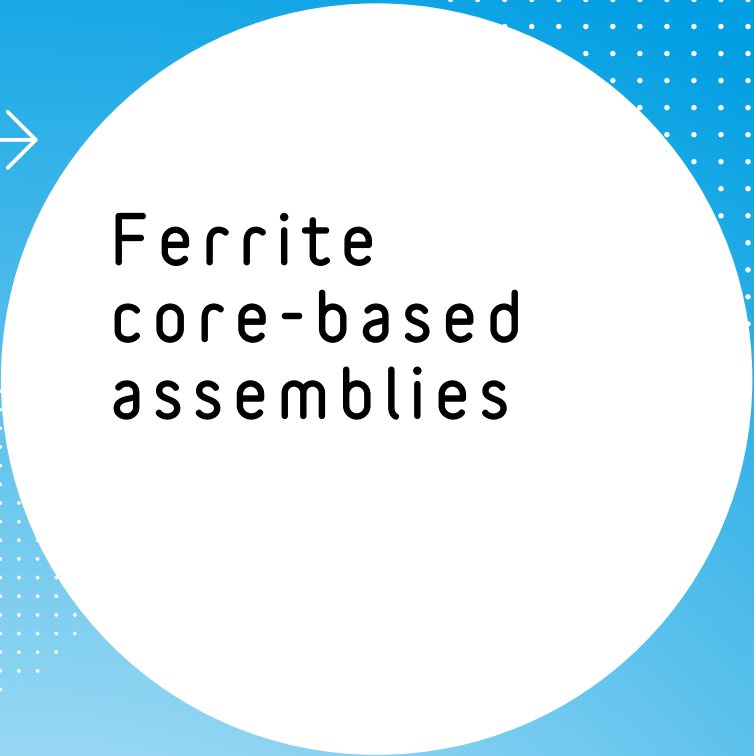

Ferrite core-based assemblies

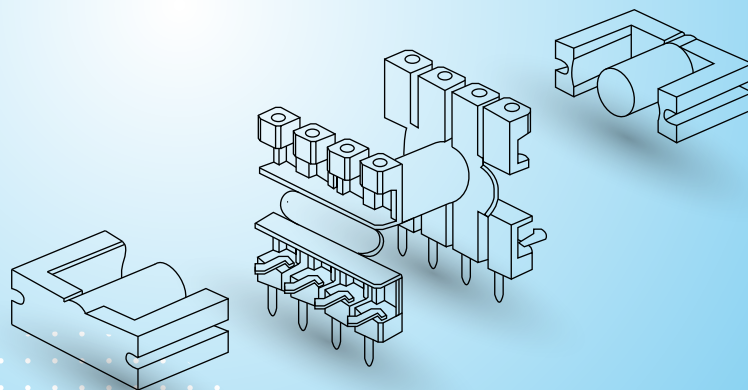
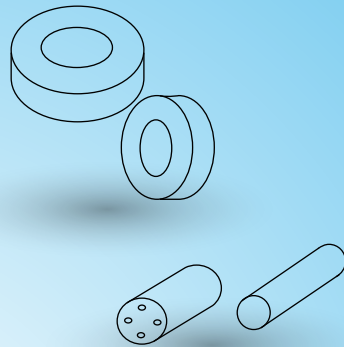
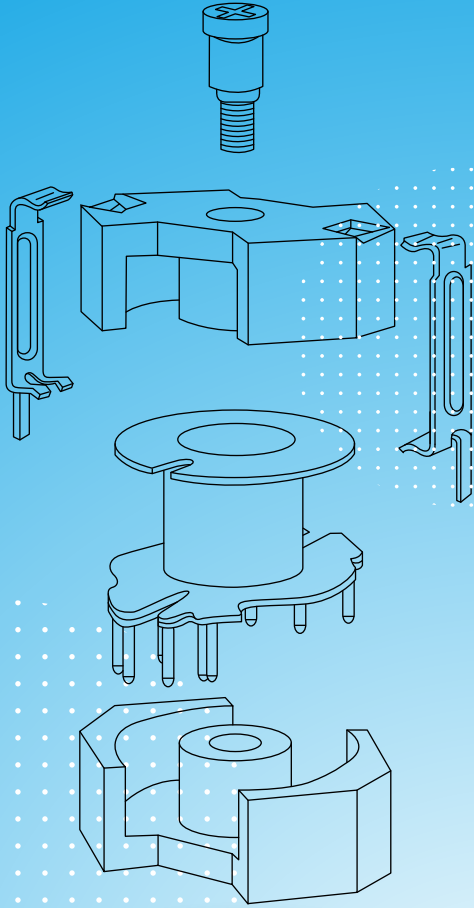

Ferrite core-based assemblies

GENERAL INFORMATION ABOUT FERRITE MATERIALS



Our partner **Ferroxcube** proposes an extensive range of ferrite cores, ferrite toroids and accessories that you can also view on the www.ferroxcube.com website.

COMMENT

Isolectra Martin has a grinding, epoxying and gluing workshop for ferrite units according to drawings. We grind the AL values or air gapping to the required specifications.

→ Materials for each power conversion need

3C91 - 3C92 - 3C93 - 3C94 - 3C95 - 3C96 - 3C97

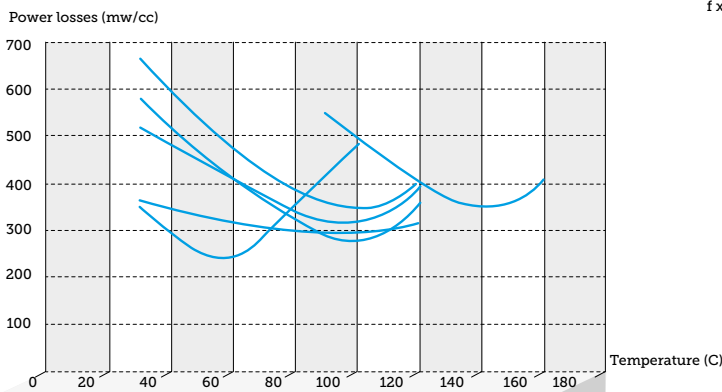

3F3 - 3F35 - 3F45 - 3F5 - 4F1

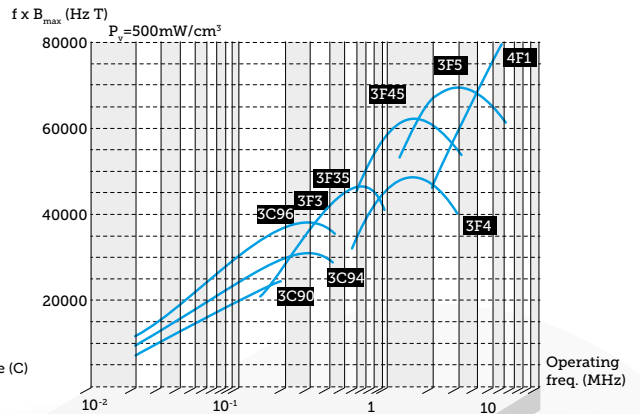

→ Low frequency power conversion

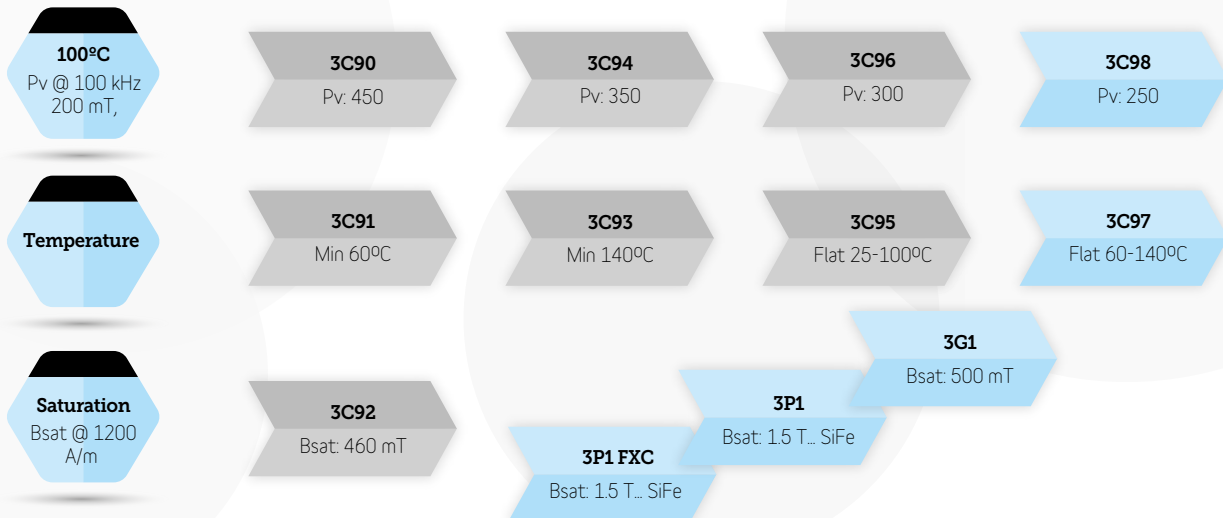

→ Power ferrite materials: low/med freq. apps.

Power losses [mW/cm³]

$\mu \pm$ 25%	kHz	25	100	100	400	500	Temp [C]mm	Bsat (min)	
	mT	200	100	200	50	50		25C	100C
3C90	2300	<80	<80	~450			100	470	380
3C91	3000		<40	<330			60	470	370
3C92	1500	<60		<400			100	540	450
3C93	1800		~50	~350		~350	140	520	430
3C94	2300	<60	<60	<400			100	470	380
3C95	3000		<50	<330	~100		25/100	530	410
3C96	2000	~40	<45	<330	<140	<250	100	500	440
3C97	3000		<45	<300	~100		100	530	410
3C98	2500			<250		<200	100	530	420

→ High frequency power conversion materials

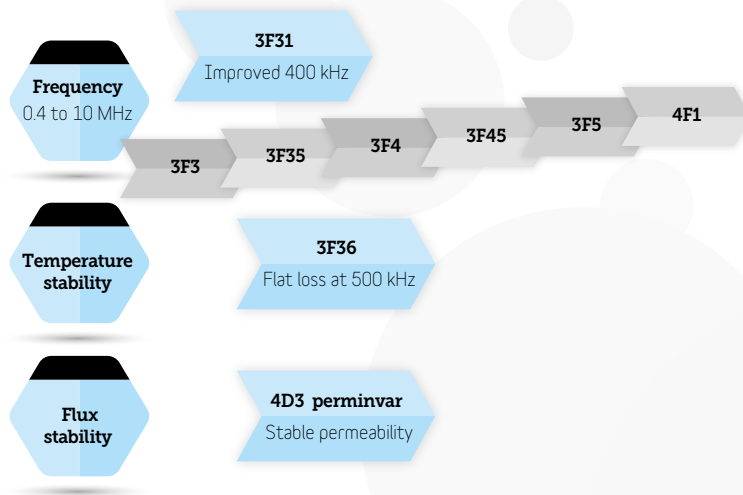

→ Power ferrite materials: high freq. apps.

Power losses [mW/cm³]

μ	kHz -100	400	500	500	1000	3000	Temp	Temp [C]mm	Bsat (min)	
	mT -100	50	50	100	30	10			25C	100C
3F3	2000	<80	<150					100	440	370
3F31	1800	<50	<100	<175				100	520	430
3F35	1400		<70	<120	<900			100	500	420
3F36	1600		<70	<120	<900			100	500	420
3F45	900					<80	<150	100	420	370
3F5	650						~100	100	380	340
4F1	80						<200	100	320	260

→ High perm grades

$\tan \delta / \mu$ (@25C) [10⁻⁶]

Material	μ	10	30	100	300	η (@20kHz 1,5-3mT) [·10 ⁻³]
		kHz	kHz	kHz	kHz	
Only small toroids	3E8	18000	10	30		
	3E7	15000	10	30		
	3E12	12000		7	25	<0.5
	3E10	10000		5	20	<0.5
	3E6	12000	10	30		<1
Special (DSL)	3E55	10000	10	30		<0.2
	3E5	10000		25	75	
	3E27	6000			15	
	3E25	6000			25	200

Ferrite core-based assemblies

GENERAL INFORMATION ABOUT FERRITE MATERIALS

→ EMI suppression grades (incl. NiZn)

Application area	Freq. range (MHz)	Material	μ_i (at 25°C)	Bsat (3000A:m)	Tc (°C)	ρ (Ω m)	Ferrite type	Available core shapes
Wideband EMI-suppression Wideband transformers Balun transformers	10 - 100	3B1	900	≈ 400	≥ 150	≈ 0.2	MnZn	BD, BDW, BDS, MLS, CMS, Cable shields, Rods, Toroids, WBS, WBC
	1 - 30	3S1	4000	≈ 400	≥ 125	≈ 1	MnZn	
	30 - 1000	3S3	350	≈ 350	≥ 225	≈ 104	MnZn	
	10 - 300	3S4	1700	≈ 350	≥ 110	≈ 103	MnZn	
	30 - 1000	4A11	700	≈ 350	≥ 125	≈ 105	NiZn	
	10 - 300	4A15	1200	≈ 350	≥ 125	≈ 105	NiZn	
	30 - 1000	4B1	250	≈ 350	≥ 250	≈ 105	NiZn	
	50 - 1000	4C65	125	≈ 400	≥ 350	≈ 105	NiZn	
30 - 1000	4S2	700	≈ 350	≥ 125	≈ 105	NiZn		

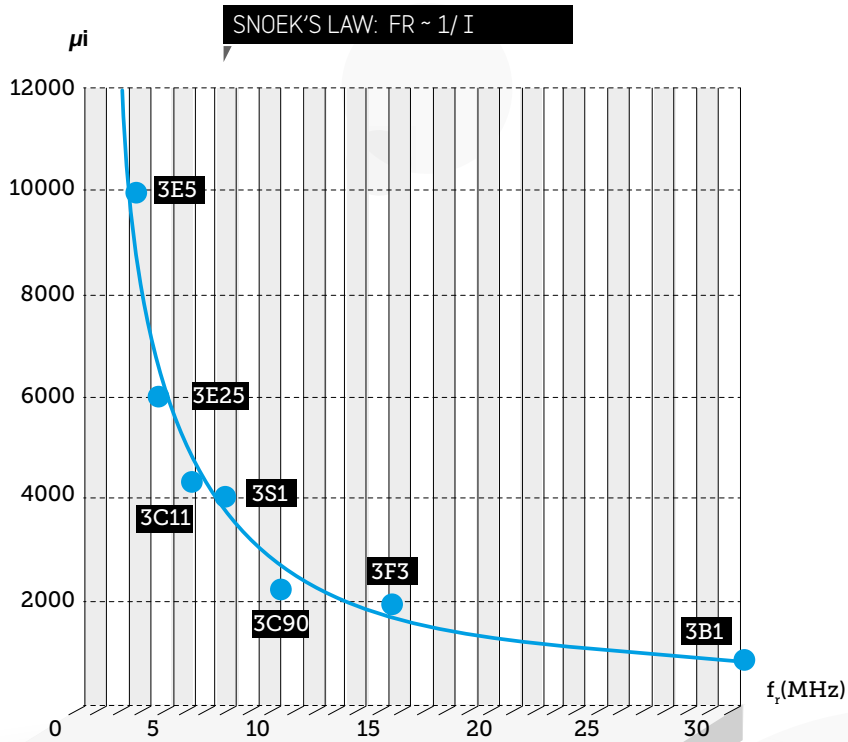

→ Materials according to the frequency

Application	Material grade	Optimum frequency														
		50	100	150	200	250	300	350	400	500	600	800	1000	2000	4000	>4000
Med. Freq. SMPS	3C90	x	x	x	x											
	3C94	x	x	x	x	x	x									
	3C96	x	x	x	x	x	x	x	x							
	3C98	x	x	x	x	x	x									
Med./high Freq. SMPS	3F3				x	x	x	x	x	x						
	3F35							x	x	x	x	x	x			
High freq. SMPS	3F45										x	x	x	x		
	3F5												x	x	x	
	4F1															x
Low temp. (60 degr) low loss	3C91	x	x	x	x	x	x									
High temp. (140 deg) low loss	3C93	x	x	x	x	x	x									
All temperature low loss	3C95	x	x	x	x	x	x	x	x							
	3F36							x	x	x	x	x	x			
Power chokes (high Bsat)	3C92	x	x	x	x											



Our partner **Weisser** proposes an extensive range of products for ferrite core mounting.

We encourage you to consult the **www.weisser.de** website or pages 137 to 157 and 161 to 165 of the Weisser Catalogue in order to access the entire range.

ST
vertical with moulded-in
pins and increased creepage
distances
EE 10

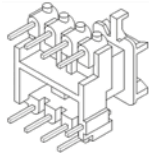

PAGE
137
Weisser
Catalogue

ST
vertical with moulded-in
pins and increased creepage
distances
EE 16

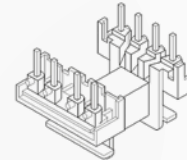

PAGE
137
Weisser
Catalogue

ST
vertical with moulded-in
pins and increased creepage
distances
EE 20 - EE 25

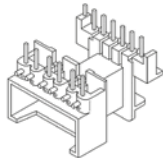

PAGE
137
Weisser
Catalogue

ST
vertical with pins
EE 12,6 - EE 16 - EE 20
EE 25 - EE 32

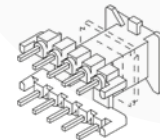

PAGES
138
141
Weisser
Catalogue

INFO:
Explanation:
Bobbins for SMD-technology

PAGE
142
Weisser
Catalogue

ST
with moulded-in pins
EE 12.6

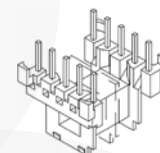

PAGE
143
Weisser
Catalogue

Ferrite core-based assemblies

VARIOUS PRODUCTS FOR FERRITE CORE MOUNTING

ST
with moulded-in pins
and pick & place cap
EE 12.6 - EE20

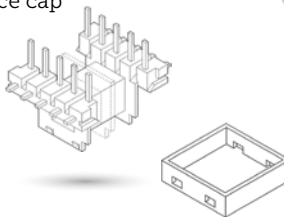

PAGES
143
147
Weisser
Catalogue

ST
with moulded-in pins
EE 16 - EE 20 - EE 25
EE 32 - EE 40

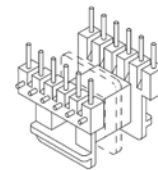

PAGES
143
147
Weisser
Catalogue

ST
with moulded-in pins
EE16

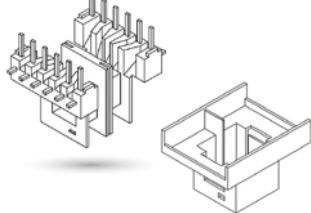

PAGE
145
Weisser
Catalogue

ST
with moulded-in pins
EE16

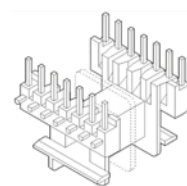

PAGES
144
145
Weisser
Catalogue

ST
with pins
EE 20

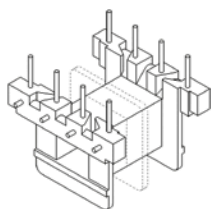

PAGES
145
146
Weisser
Catalogue

ST
with pins
EE 25 - EE 32
EE 40

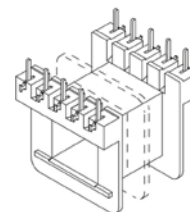

PAGE
148
Weisser
Catalogue

ST
with pins
EE 25

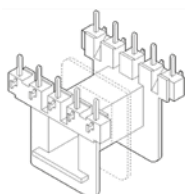

PAGE
148
Weisser
Catalogue

ST
with pins
EV 15

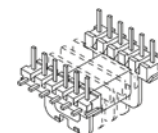

PAGE
149
Weisser
Catalogue

"O" TYPE BOX
EE 12.6 - EE 16
EE 20 - EE 25
EE 32

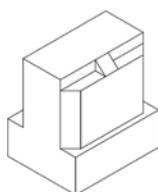

PAGES
150
151
Weisser
Catalogue

"O" TYPE BOX
EE 12.6

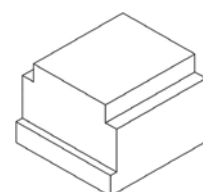

PAGE
151
Weisser
Catalogue

"O" TYPE BOX
EE 16 - EE 20

PAGES
152
154
Weisser
Catalogue

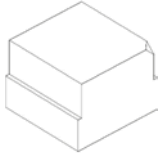

"O" TYPE BOX
EE 20 - EE 25
EE 32 - EE 40

PAGES
153
157
Weisser
Catalogue

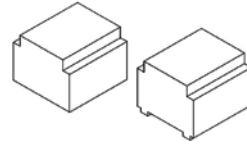

"O" TYPE BOX
EE 20 - E 25
ED 25

PAGES
154
155
Weisser
Catalogue

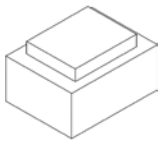

"O" TYPE BOX
EE 12.6 - EE 16
EE 20 - ED 12.6
ED 16

PAGES
152
154
Weisser
Catalogue

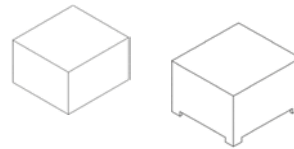

"O" TYPE BOX
EE 25L - EE 32L

PAGE
156
Weisser
Catalogue

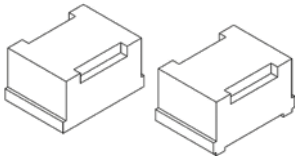

BOX
with fixings
"K" type
EE 40

PAGE
157
Weisser
Catalogue

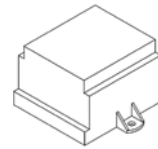

ST
vertical with pins
ETD 19 - ETD 24
ETD 29 - ETD 34
ETD 39 - ETD 44
ETD 49 - ETD 54
ETD 59

PAGE
161
Weisser
Catalogue

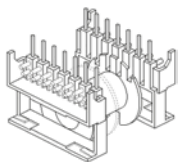

ST
with pins
ETD 19 - ETD 24
ETD 29 - ETD 34
ETD 39 - ETD 44
ETD 49 - ETD 54
ETD 59

PAGE
161
Weisser
Catalogue

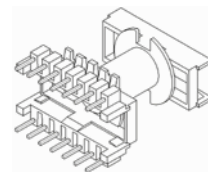

MOUNTING CLIP
ETD 29 - ETD 34
ETD 39 - ETD 44
ETD 49 - ETD 54
ETD 59

PAGE
162
Weisser
Catalogue



Ferrite core-based assemblies

VARIOUS PRODUCTS FOR FERRITE CORE MOUNTING

ST
with moulded-in pins
EFD 15 - EFD 25

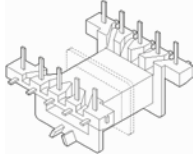

PAGE
162
Weisser
Catalogue

ST
with moulded-in pins
EP 7 - EP 13

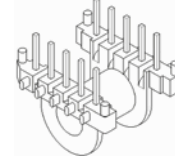

PAGE
163
Weisser
Catalogue

ST
with moulded-in pins
RM 6

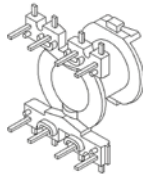

PAGE
163
Weisser
Catalogue

"O" TYPE BOX
ETD 29 - ETD 34
ETD 39 - ETD 44
ETD 49

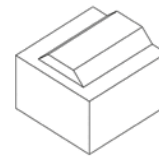

PAGE
164
Weisser
Catalogue

"O" TYPE BOX
EFD 20 - EFD 30

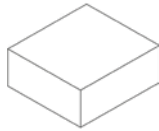

PAGE
164
Weisser
Catalogue

"O" TYPE BOX
RM 5 - RM 6

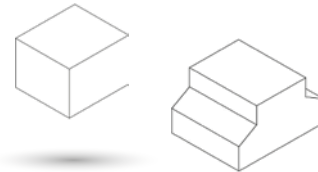

PAGE
165
Weisser
Catalogue



All types of accessories

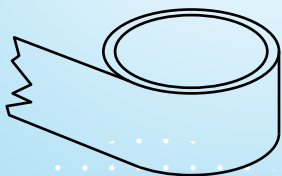
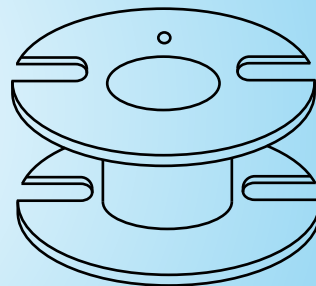
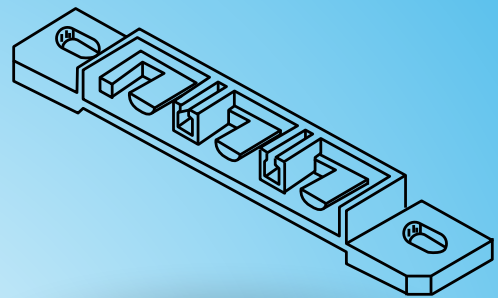
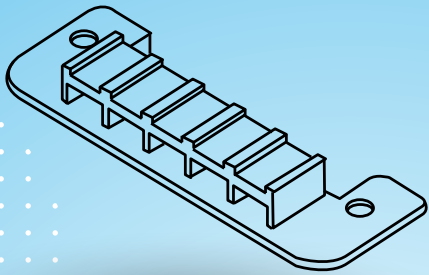

All types of accessories

ACCESSORIES, PINS AND TERMINALS



Our partner **Weisser** proposes an extensive range of accessories, pins and terminals.

We encourage you to consult the **www.weisser.de** website or pages 183 and following of the Weisser Catalogue in order to access the entire range.

BOBBINS
for pot cores 1/2 stack height



PAGE

183

Weisser
Catalogue

BOBBINS
for pot cores

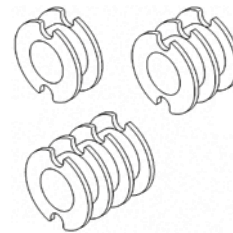

PAGE

183

Weisser
Catalogue

BOBBINS
for air cored applications



PAGE

184

Weisser
Catalogue

**SPECIAL ROUND
BOBBINS**

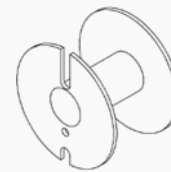

PAGE

185

Weisser
Catalogue

HOUSINGS
for plug-in charger

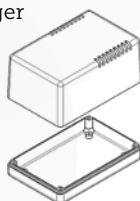

PAGES

186

188

Weisser
Catalogue

TERMINAL RAIL



PAGES

189

190

Weisser
Catalogue

TERMINAL COVER
for LP/ST bobbins

PAGES
190
191
Weisser
Catalogue

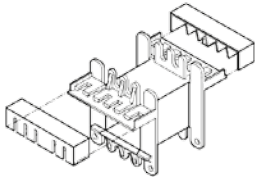

TERMINAL RAIL

PAGE
192
Weisser
Catalogue

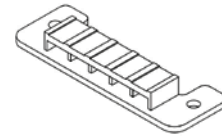

PLUG FRAME
for Rast5

PAGES
193
195
Weisser
Catalogue

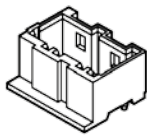

SLOTS
for TCO

PAGE
196
Weisser
Catalogue

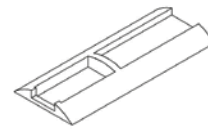

INSULATING SHOULDER
WASHERS
Size 3-12

PAGES
196
197
Weisser
Catalogue



INSULATING SHOULDER
WASHERS
Size 3-10

PAGE
197
Weisser
Catalogue



EI FIXING PLATES

PAGE
198
Weisser
Catalogue

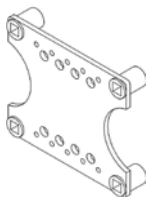

EI FIXING PLATES

PAGE
199
Weisser
Catalogue

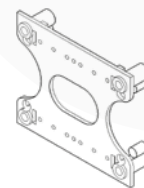

FIXING RAILS

PAGES
199
200
Weisser
Catalogue

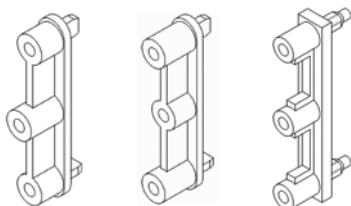

CORNER PIECES

PAGES
200
201
Weisser
Catalogue



All types of accessories

ACCESSORIES, PINS AND TERMINALS

STRAIN RELIEF SLEEVES

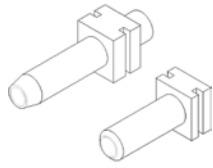

PAGE
201
Weisser
Catalogue

STRAIN RELIEF SLEEVES single/double

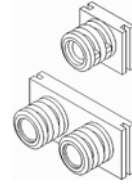

PAGE
201
Weisser
Catalogue

SIDE INSULATION COVERS

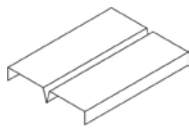

PAGES
202
205
Weisser
Catalogue

PINS GROUP 1

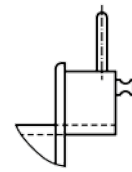

PAGE
209
Weisser
Catalogue

TERMINALS GROUP 2

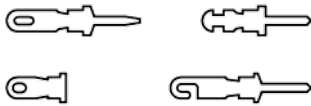

PAGES
210
211
Weisser
Catalogue

TERMINALS GROUP 3

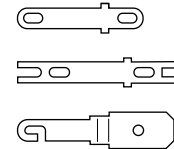

PAGES
212
215
Weisser
Catalogue

TERMINALS GROUP 4

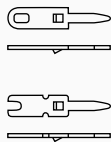

PAGES
214
215
Weisser
Catalogue

TERMINALS GROUP 5

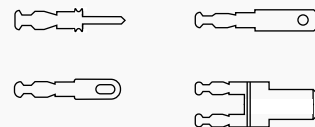

PAGES
216
217
Weisser
Catalogue

TERMINALS GROUP 6

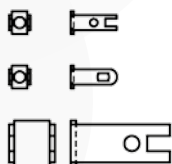

PAGES
216
217
Weisser
Catalogue

TERMINALS GROUP 7 with sketch of pin direction

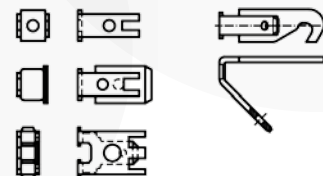

PAGES
218
221
Weisser
Catalogue

TERMINALS GROUP 8

PAGES
222
223
Weisser
Catalogue

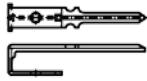

TERMINALS GROUP 10

PAGES
222
223
Weisser
Catalogue

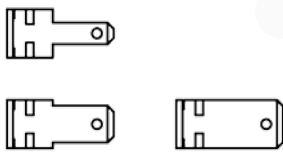

TERMINALS GROUP 12

PAGES
224
225
Weisser
Catalogue

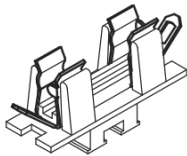

FUSE HOLDER
GROUP 13

PAGES
224
225
Weisser
Catalogue

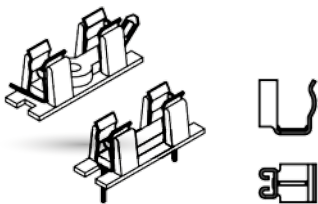

TERMINALS GROUP
9 Rast 5

PAGES
222
223
Weisser
Catalogue

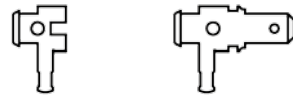

TERMINALS GROUP 11

PAGES
222
223
Weisser
Catalogue

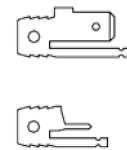

CONNECTING PARTS
FUSE HOLDER
GROUP 12

PAGES
224
225
Weisser
Catalogue

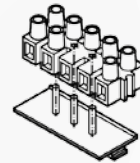

BUSHING FOR BOXES
GROUP 13

PAGES
224
225
Weisser
Catalogue

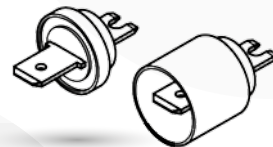

All types of accessories

CRIMP TERMINALS - C.I PINS

→ Crimp terminals type A

CODE: B62212

62.12.11

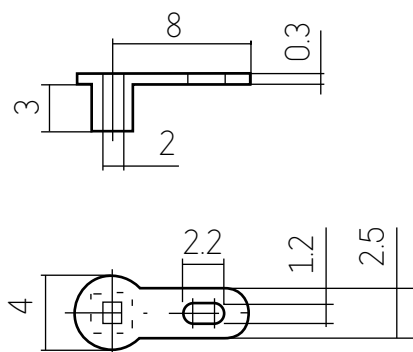

CODE: B62057

62.1057.11

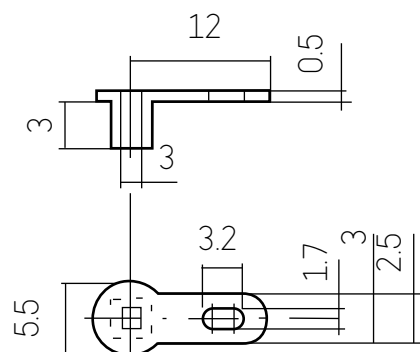

CODE: B62071

62.1071.11

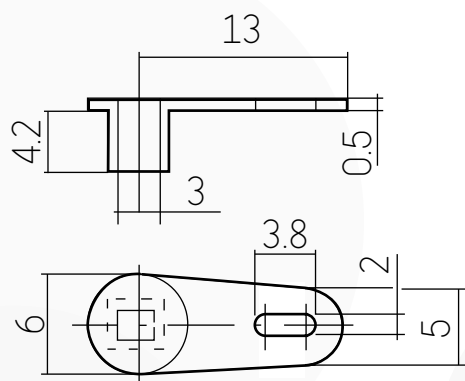

CODE: B62060

62.10760.11

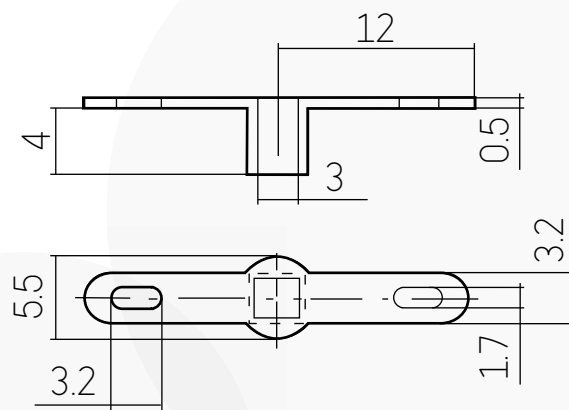

CODE: B77060

77.1060.31

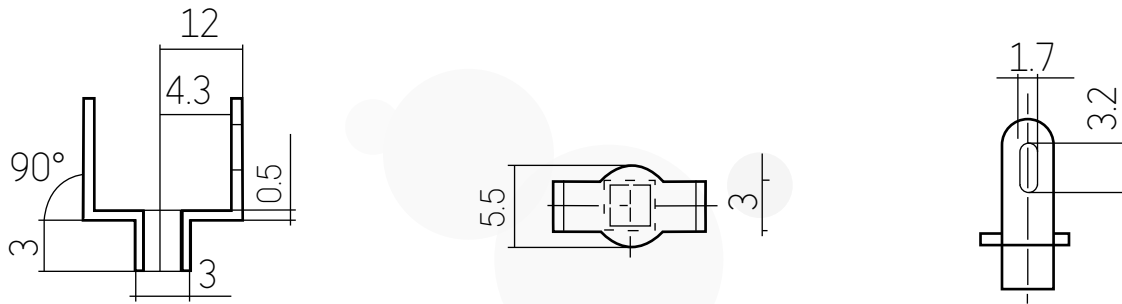

CODE: B63291

63.1291.11

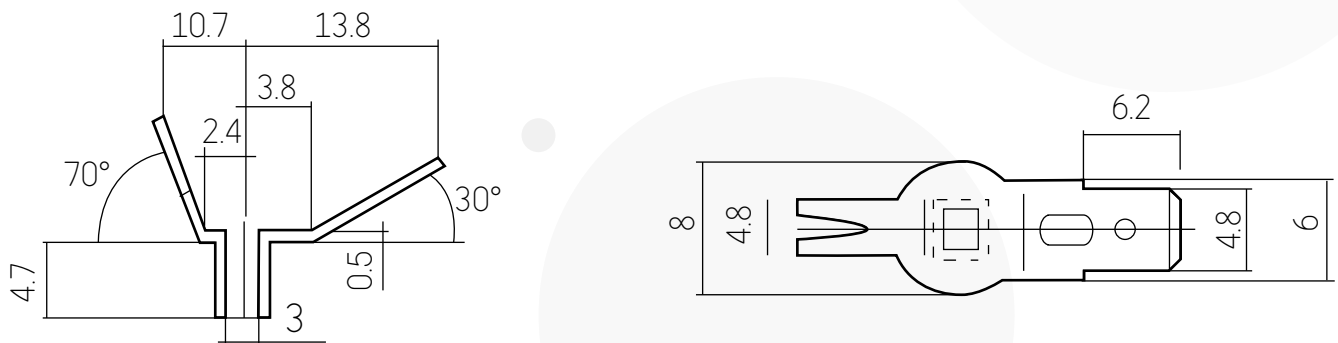

All types of accessories

ADHESIVE TAPES



Our partner **3M** proposes an extensive range of adhesives for electrical insulation which you can also view on the www.3mfrance.fr website.

→ Metallic adhesive tapes

Tape	UL Class	Film	Adhesive	Total thickness (mm)	Resistance (ohms)	Breaking stress (N/10mm)	Adhesion to steel (N/10mm)	Length Rx (m)	Comments	
1170	yes	F	Aluminium	Acrylic conductors	0.081	0.01	35	3.8	16.5	Aluminium tape for multi-purpose shielding
1181	yes	F	Copper	Acrylic conductors	0.066	0.005	44	3.8	16.5	Conductive copper tape and for multi-purpose shielding
1182	yes	F	Copper (double sided glue)	Acrylic conductors	0.088	0.01	44	3.8	16.5	Coated on each side with a conductive adhesive
1183	yes	F	Tinned copper tape	Acrylic conductors	0.066	0.005	44	3.8	16.5	Resistant to oxidation for lasting protection against electromagnetic interference
1194	yes	F	Copper	Acrylic	0.076	N/A	44	4.4	16.5	Multi-purpose Conductive copper tape non-conductive adhesive
1245	yes	F	Embossed copper	Acrylic	0.101	0.001	44	3.8	16.5	Conductive adhesive direct contact of the metal with the substrate
1267	yes	F	Embossed aluminium	Acrylic	0.127	0.005	35	3.8	Consult us	Conductive adhesive direct contact of the metal with the substrate
1345	yes	F	Embossed copper tin plated	Acrylic	0.101	0.001	44	3.9	16.5	An oxidation resistant conductive adhesive for lasting protection against electromagnetic interference

Metallic adhesive tapes

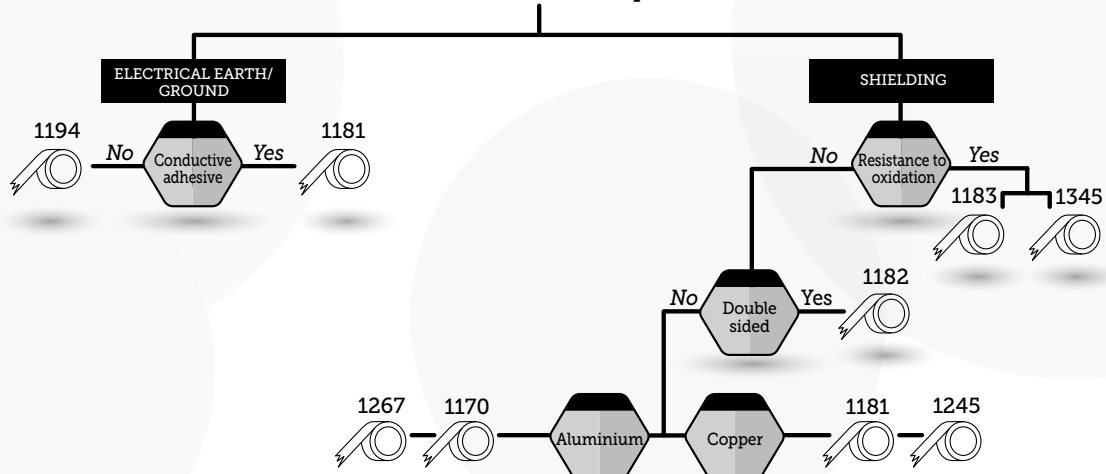

→ Electrical tapes

Tape	UL Class	Film	Adhesive	Maximum operating temp. (C°)	Breakdown voltage (volts)	Breaking resistance (N/10mm)	Length Rx (m)	Total thickness (mm)	Comments
1	yes B	Epoxy film	Acrylic	130°	5,000	44	66	0.09 mm	Flame retardant, resistant to solvents
5	yes B	Polyester film	Acrylic	130°	5,000	44	66	0.06 mm	transparent adhesive tape
Super 10	yes F	Epoxy film	Rubber	155°	8,000	79	55	0.14 mm	Conformable, resistant to welding
27	yes B	Fibre glass	Rubber	130°	3,000	262	55	0.18 mm	Conformable, printable, resistant to abrasion
28	yes A	Acetate fabric	Rubber	105°	3,500	102	55	0.20 mm	Conformable, printable
56	yes B	Polyester film	Rubber	130°	5,500	44	66	0.06 mm	
60	yes H	PTFE film	Silicon	180°	9,500	35	33	0.10 mm	Use at high temperatures. Excellent insulation, very conformable, not printable
69	yes H	Fibre glass	Silicon	180°	3,500	262	33	0.18 mm	Use at high temperatures, conformable, Printable
75	yes B	Double sided	Rubber	130°	3,500	21	33	0.10 mm	Conformable, good electrical insulation for application to miniature and electronic coils
79	yes F	Fibre glass	Acrylic	155°	3,000	262	55	0.18 mm	Conformable, Printable, resistant to solvents
92	yes H	Polyimide film	Silicon	180°	7,500	53	33	0.08 mm	Thin film, Printable, application at high temperatures, resistant to welding
1350F-Y1	B	Polyester film	Acrylic	130°	5 500 7 000	44 88	66	0.06 mm or 0.08 mm	2 thicknesses of film available, (0.025 and 0.050 mm) resistant to solvents

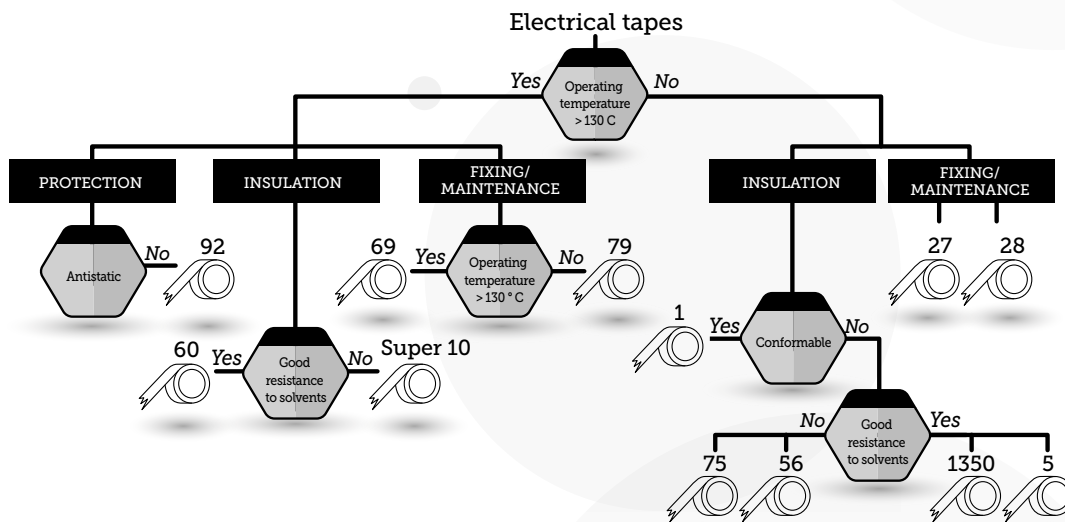

All types of accessories

INSULATING MATERIAL

→ Kraft electrical

Thickness	Weight g/m ²	Breakdown voltage (V)	Length Rx (m)	Code
5/100	42	350	600	F55020P
7/100	55	490	450	F55030P
10/100	85	700	300	F55040P
15/100	120	1050	215	F55050P
20/100	158	1400	130	F55060P

INFORMATION

- Class A 105°C
- Insulating paper, 100% cellulose
- For insulating impregnated or immersed transformers
- Width of cut to order (specify at the time of ordering)
- Notching on request from 10/100

→ Presspahn

Thickness	Weight g/m ²	Breakdown voltage (V)	Length Rx (m)	Code
10/100	126	970	300	F55070P
20/100	265	1600	150	F55090P
30/100	350	2400	100	F55100P
50/100	600	5000	55	F55110P

INFORMATION

- Class A 105°C
- Insulating board for use between layers and finishing transformers
- Width of cut to order (specify at the time of ordering)
- Notching on request

→ Fisceroid - Transformer board

Thickness	Weight g/m ²	Breakdown voltage (V)	Length Rx (m)	Code
10/100	120	2150	300	F55120P
15/100	200	3300	200	F55130P
20/100	250	4550	150	F55140P
30/100	350	5800	100	F55150P
50/100	600	6700	55	F55160P

INFORMATION

- Grey - black
- Class A - 105°C
- Insulating cardboard, 100% cellulose
- Width of cut to order (specify at the time of ordering)
- Notching on request

→ Crystal paper

Thickness	Weight g/m ²	Code
3/100	40 (+ or - 4%)	F55010P

INFORMATION

- No notching

→ Mylarcellite

Total thickness (mm)	FILM thickness	Weight g/m ²	Break-down voltage (V)	Packed in reels (m)	Observations	Code
0.06	0.025	70	3000	400	Kraft duplex	F56010P
0.1	0.05	110	7000	300	Duplex	F56020P
					Transformer board	
0.13	0.025	168	4000	250	Kraft duplex	F56030P
0.18	0.025	231	5000	200	Kraft duplex	F56040P
0.23	0.025	293	5200	200	Kraft duplex	F56050P

INFORMATION

- Class E 120°C
- An insulating material made of a polyester film (mylar or terphane) on which a smooth or a kraft transformer board is laminated of which the role is to absorb varnish or impregnating substances
- Width of cut to order (specify when ordering)
- Notching on request for a minimum width of 20 mm

→ Polyester film

Thickness	Weight g/m ²	Breakdown voltage (V)	Roll length (m)	Code
0.05	70	9000	400	F56250P
0.075	105	13500	200	F56260P
0.1	140	18000	200	F56270P
0.125	174	22500	200	F56280P
0.175	244	31500	100	F56290P
0.25	265	45000	80	F56300P

INFORMATION

- Class B - 130°C
- Ethylene glycol terephthalate film
- Electrical insulation between layers and finishing small transformers
- Width of cut to order (specify at the time of ordering)
- Notching on request from 5/100 for a minimum width of 20 mm

→ Nomex paper

Thickness	Weight g/m ²	Breakdown voltage (V)	Roll length (m)	Code
0.08	63	1600	200	F56110P
0.13	112	2300	200	F56120P
0.18	168	2600	200	F56130P
0.25	244	3000	200	F56140P

INFORMATION

- Class C - 220°C (UL approved 220°C)
- E 34 - 739 January 88
- Calendered insulation paper made from aramid fibres for dry or immersed transformers. Electromagnets
- Notching on request

All types of accessories

INSULATING SLEEVES

→ Silicone rubber sleeve SRS

Reference	Ø int. in mm	Ø ext. in mm	Length in m	Code
302	0.3	0.7	25	A49401
502	0.5	0.9	25	A49402
702	0.7	1.1	25	A49403
804	0.8	1.6	25	A49404
1004	1	1.8	25	A49405
1504	1.5	2.3	25	A49406

INFORMATION

- Class H
- Various colours
- Very flexible expansion, 300% without tearing
- Temperature stability: 200°C (300°C temporary)
- Breakdown strength: 10 KV/mm lining

→ Teflon PTFE sleeve (TW)

Gauge	Ø min. int. in mm	Packing in m	Gauge	Ø min. int. in mm	Packing in m
0	8.25	25	14	1.62	152
1	7.34	25	15	1.45	152
2	6.55	50	16	1.29	152
3	5.81	50	17	1.14	152
4	5.18	50	18	1.02	152
5	4.62	50	19	0.91	152
6	4.11	100	20	0.81	152
7	3.66	100	21	0.74	152
8	3.28	100	22	0.66	152
9	2.89	152	23	0.58	152
10	2.59	152	24	0.51	152
11	2.31	152	26	0.41	152
12	2.06	152	28	0.33	152
13	1.83	152	30	0.25	152

INFORMATION

- Class F
- A sleeve composed of fluorine resins giving it very high resistance
- Resistance between -200°C and +280°C
- Resistant to corrosion and abrasion
- High dielectric coefficient

→ Heat shrink sleeve TRS

Reference	Before shrinkage mm	After shrinkage mm	Packing in m	Code
GTR 120	1.2	0.45	1.2	A49601
GTR 160	1.6	0.45	1.2	A49602
GTR 240	2.4	0.5	1.2	A49603
GTR 320	3.2	0.5	1.2	A49604
GTR 480	4.8	0.5	1.2	A49605
GTR 640	6.4	0.65	1.2	A49606
GTR 950	9.5	0.65	1.2	A49607
GTR 1270	12.7	0.65	1.2	A49608
GTR 1900	19	0.75	1.2	A49609
GTR 2540	25.4	0.9	1.2	A49610

INFORMATION

- Irradiated polyolefin sleeve, very flexible.
- Military grade -55°C to +135°C
- Self-extinguishing
- Shrinkage ratio 2/1
- Shrinkage temperature 10°C / 115°C
- Black colour (other colours on request)

→ "Glass braid" sleeve GBS

Ø int. mm	Tolerance on Ø ±	Packing in m	Code	Ø int. mm	Tolerance on Ø ±	Packing in m	Code
0.5	0.2	100	A49105	4	0.2	100	A49112
0.8	0.2	100	A49106	5	0.2	100	A49113
1	0.2	100	A49107	6	0.3	100	A49114
1.5	0.2	100	A49108	7	0.3	100	
2	0.2	100	A49109	8	0.3	100	A49115
2.5	0.2	100	A49110	10	0.5	50	A49116
3	0.2	100	A49111				

INFORMATION

- Class F
- An electrically insulating sleeve made from from a fibreglass braid coated with polyurethane varnish.
- Temperature 155°C.
- Dielectric strength according to the diameter.
- Straw colour and others.

→ Silicon "glass braid" sleeve GES

Ø in mm	Tolerance on Ø ±	Packing in m	Code	Ø in mm	Tolerance on Ø ±	Packing in m	Code
0.5	0.2	100	A49***	4	0.2	100	A49***
1	0.2	100		5	0.3	100	
1.5	0.2	100		6	0.3	100	
2	0.2	100		7	0.3	100	
2.5	0.2	100		8	0.3	100	
3	0.2	100		10	0.5	50	

INFORMATION

- High temperature electrical insulation from -60°C to +220°C.
- An electrically insulating sleeve made from from a fibreglass braid coated with a silicone elastomer.
- Temperature stability -60°C TO +220°C (MIL standard Q03190 C) resistance to fire UL standard 1441.
- Standard red-brown colour.

All types of accessories

MISCELLANEOUS

→ Cyanoacrylate tube



Tube of 2 grammes
Code: B49006



Tube of 20 grammes
Code: B49005

→ CNOMO type profiles for fuse transformers

A	B	C	X	Y1	Y2	Screw	Assembly/Code	
							1	2
170	135	190	114	100	120	M6	C23452	C23462
170	145	190	126	100	120	M6	C23452	C23464
180	165	190	144	100	120	M6	C23454	C23466
190	185	190	168	100	120	M6	C23454	C23468
190	185	190	168	100	120	M6	C23454	C23468
230	220	250	200	120	150	M8	C23456	C23470
250	250	250	230	120	150	M8	C23458	C23470

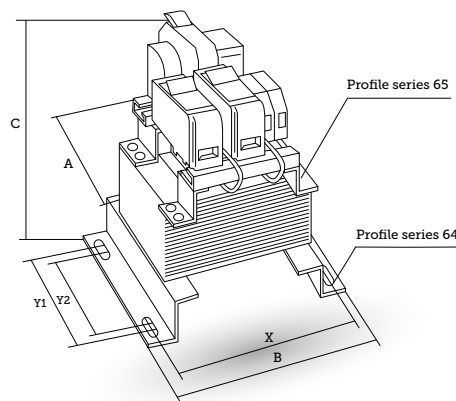

Fixing profile series 64

Y1	Y2	Y3	I	A	B	C	D	G	E	P	Code	Ref.
80	100	115	6.6	56	14	18.5	25	4.5	1.5	8		64.70/84
93.6	120	135	6.6	59	16	19.3	25.3	5	1.5	8	C23452	94.96/108
126	120	135	6.6	76	20	18.5	30	6	1.5	8	C23454	64.126/150
100	120	135	6.6	100	20	18.5	30		1.5	8		64.126/150a
120	150	170	9	120	29	23	35	7	2	10	C23456	64.180
120	150	170	9	120	29	37		7	2	10	C23458	64.180a

Material: Zinc plated steel

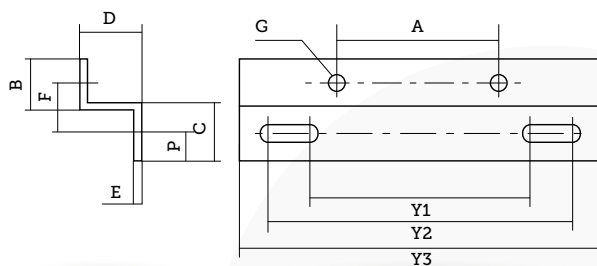

Fixing profile series 65

B	C	D	E	F	G	H	P	L	Code	Ref.
22	8	16	18	21	96	80	5	90	C23462	65.96
18	8		24	15	106	90	5	105	C23464	95.108
14	10.5	21		15	126	105	6	105	C23466	65.126
14			18	21	146	125	6	125	C23468	65.150
14	12	26	28	15	174	150	7	125	C23470	65.180

Material: Zinc plated steel

The length L can be adjusted to the request

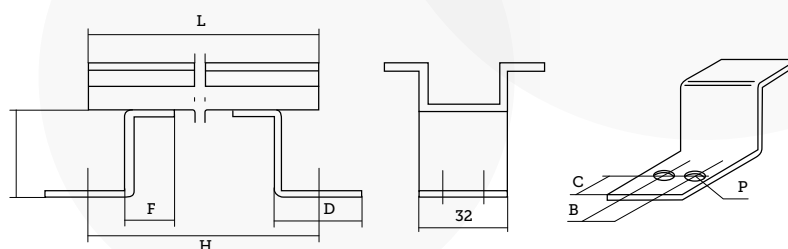

→ Hexagonal spacers "Colodex"

Materials: Zinc plated steel, nickel plated brass, stainless steel

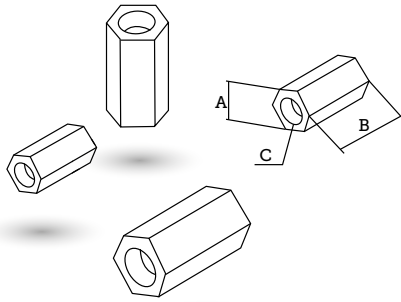

→ Cylindrical "C" spacers

Materials: Nickel plated brass, stainless steel, nylon...

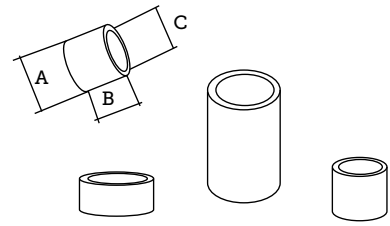

→ "Colodiso" cylindrical spacers

Materials: Nylon

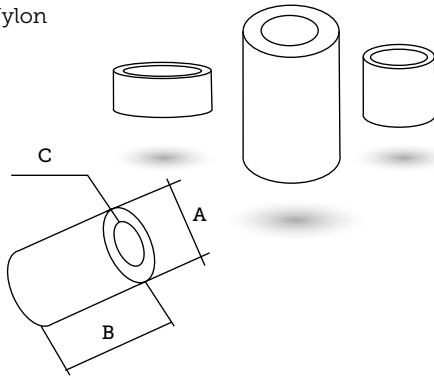

→ 6 pan "Piliex" pillars

Materials: Zinc plated steel, nickel plated brass, stainless steel

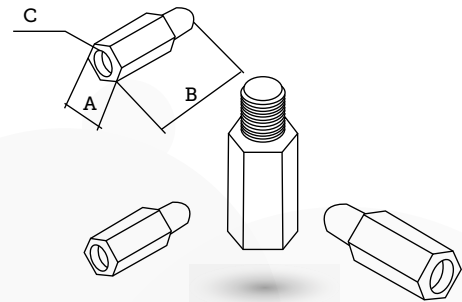

→ Insert for printed "Colosert" cores

Materials: Tinned steel, stainless steel

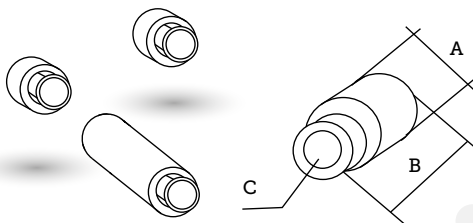

→ Rivet nuts

Materials: Zinc plated steel, nickel plated brass, stainless steel

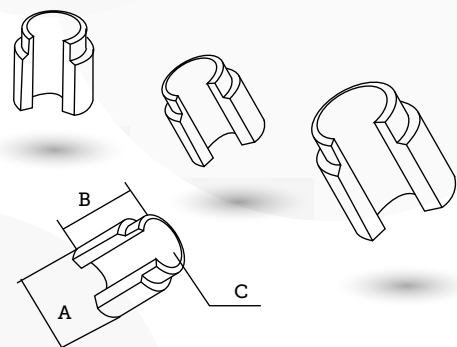

→ Rivet nuts or for crimping off plan

For sheet metal or epoxy glass adapted according to demand, nuts and quick fasteners with metric or US thread; Fasteners by crimping or riveting, captive screw assemblies.

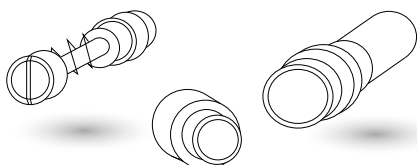

General terms and conditions of sale

All orders imply acceptance of our general terms and conditions of sale, notwithstanding any contrary provision which appears in your general terms and conditions of purchase, on your letterhead or in your commercial documents.

→ Acceptance of orders

The orders addressed to us, even through our employees, shall only become final when they have been confirmed in writing by us, unless they have been executed prior to acceptance, with the execution constituting a presumption of acceptance. Any subsequent modification of the order shall also be subject to our express confirmation.

→ Delivery deadlines

The delivery deadlines, which we will always endeavour to meet, are only provided for information purposes and a delay in delivery may not constitute a cause for cancelling the order, or give rise to any damages or transport at our expense.

→ Transport and delivery

Unless otherwise stipulated, goods travel at your risk regardless of the mode of transport or the terms of payment of the transport costs. You are invited to carefully check the condition of the goods upon delivery before granting discharge to the carrier. No claim shall be admitted concerning any damage or loss during transport, which you will personally handle. All deliveries of goods give rise to the signature of a delivery slip. You must indicate any reservations concerning the delivered goods on the delivery slip. Otherwise, no claim may be admitted concerning the nature and the quantity of the goods delivered. The carrier must be informed of any damage discovered after transport within 48 hours of delivery of the goods by registered letter with acknowledgement of receipt.

→ Prices and payment procedures

Our prices are invoiced on the basis of the tariffs in force on the date of the order, not including transport and packaging, unless otherwise specified. Our invoices are payable to our domicile upon receipt unless otherwise specified. Failure to pay our supplies on the date payment is due shall, on the one hand, render all the amounts which remain due immediately payable, regardless of the agreed payment method and payment period and, on the other hand, give rise to the payment of damages and default interest equivalent to two times the legal interest rate in force, without the necessity for any prior notice. Any remittal of the file to a recovery service shall also give rise, as additional compensation, to the payment of the costs incurred by this service, fixed at a flat rate of 15% of the amounts remaining due to us. The non-payment of any amount when due shall also automatically give rise to the suspension of deliveries.

→ Liabilities - Warranties

The warranty only applies if the customer has complied with all the general obligations of this contract and in particular with the terms of payment. In the event of a hidden and acknowledged defect declared within 15 days of delivery, our warranty is limited solely to the replacement of the defective parts in the conditions defined hereafter:

- our warranty does not apply for incidents which are the result of unforeseen circumstances or force majeure events,
- the buyer must inform us at the earliest opportunity and in writing of any defects in the goods and provide us with all documents supporting its claim,

The buyer undertakes to grant us every facility to verify and

remedy these defects, and shall abstain, unless with our prior and express agreement, from carrying out any repairs or having any repairs carried out by a third party.

- the return of defective parts may only be carried out with our prior and express agreement and at the buyer's expense, it being expressly understood that such return does not prejudice our decision.

Our liability is strictly limited to the obligations thus defined and it is expressly agreed that we shall not be bound to pay any other indemnity on any grounds whatsoever.

→ Cancellation of the order

Any cancellation of the order prior to delivery shall automatically give rise to the cancellation of the sale, and we shall withhold any down payments already made as damages. Any refusal to take delivery of the goods shall also give rise to the automatic cancellation of the sale, but in this case the cancellation of the sale shall give rise to the invoicing, as damages, of a lump-sum penalty equivalent to thirty percent of the price of the order, including tax, with any down payments already made being deducted from the amount of this penalty.

→ Claims upon delivery

Any claims concerning the goods delivered must be made within 30 business days of receipt of the goods.

→ Retention of title clause

- 1) We retain ownership of the goods delivered until the full payment of their price including, as the case may be, any penalties and late interest and, in the event of the issue of cheques or trade bills, until they are effectively credited to our account.
- 2) Throughout the duration of the retention of title period, as the risks are transferred to the buyer upon the departure of the goods from our warehouse, the buyer must insure the goods against all risks and damage.
- 3) In the event of the total or partial non-payment of the price when due, we may request, automatically and without the necessity for any formality, the return of any goods which have not been fully paid, including the goods which are normally payable on a later date. This return, carried out at the cost and risk of the buyer, does not constitute a cancellation of the sale.

→ Jurisdiction

It is expressly agreed that the Court of Commerce of AMIENS shall have sole jurisdiction to hear any disputes relating to this sale, even when there are several defendants or in the event of the introduction of third parties or interlocutory proceedings, regardless of the provisions of the buyer's general terms and conditions of purchase. The issue or acceptance of a bill of exchange or means of payment does not give rise to novation or an exception to this exclusive attribution of jurisdiction.



CCHP - Photo Samuel Dhote

Over **50** years of experience

600 clients place their trust in us

15,000 references

Deliverable within **24H** if items available in stock

20,000 order lines delivered per year

7% of turnover allocated to investment each year



ISOLECTRA martin

ZAC HAUTE PICARDIE
80200 Estrées Déniecourt
FRANCE

 +33 (0)3 22 87 66 00

 +33 (0)3 22 87 00 62

contact@isoelectra.fr

www.isoelectra.fr